

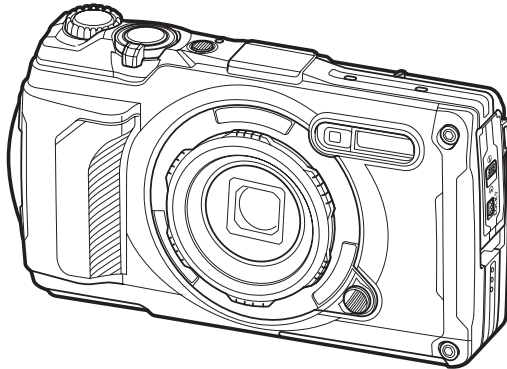

DIGITAL CAMERA

OM SYSTEM TG-7

Instruction Manual





EN

Model No. : IM032

- Thank you for purchasing our digital camera. Before you start to use your new camera, please read these instructions carefully to enjoy optimum performance and a longer service life.
- **Be sure you have read and understood the contents of “SAFETY PRECAUTIONS”, before using this product. Keep these instructions available for future reference.**
- We recommend that you take test shots to get accustomed to your camera before taking important photographs.
- The screen and camera illustrations shown in this manual were produced during the development stages and may differ from the actual product.
- If there are additions and/or modifications of functions due to firmware update for the camera, the contents will differ. For the latest information, please visit our website.







Table of Contents

Introduction	11
Before You Begin.....	11
User Registration.....	11
Installing PC Software/Apps.....	12
About This Manual.....	13
How to find what you want to know.....	13
How to read this manual.....	14
Names of parts.....	15
Preparation	17
Unpacking the Box Contents.....	17
Attaching the Strap.....	18
Inserting and Removing the Battery and Card.....	19
Inserting the battery and card.....	19
Removing the battery.....	20
Removing the card.....	21
Usable cards.....	21
Charging the Battery.....	23
Charging the battery using an optional USB-AC adapter.....	23
Charging with a USB device.....	25
Turning the Camera On.....	27
Sleep Mode.....	27
Initial Setup.....	28
What to Do If You Can't Read the Display.....	30
Shooting	31
Information displays while shooting.....	31
Switching the information display.....	33
Shooting Still Pictures.....	35
Shooting modes.....	35
Using the zoom.....	37
Letting the camera choose the settings (AUTO mode).....	38





Letting the camera choose aperture and shutter speed (P : Program AE)	39
Choosing aperture (A : Aperture-Priority AE)	41
Shooting in scene mode (SCN mode)	43
Types of scene modes	43
[Live Composite]: Live composite photography	46
[Panorama]: Shooting a panorama	47
Shooting at very close range ( mode)	49
Matching settings to underwater scenes ( mode)	51
Using Custom Modes (Custom Mode C1/C2)	52
Saving settings	52
Recalling settings	53
Recording movies	54
Recording movies in photo shooting modes	54
Recording movies in movie mode ( mode)	55
Shooting Settings	56
Shooting settings	56
Direct Buttons	57
Settings accessible via Direct Buttons	57
Controlling exposure (Exposure Compensation)	58
Adjusting Exposure Compensation	58
Zoom (digital teleconverter)	59
Sequential shooting/using the self-timer	60
Shooting without a release time lag (Pro Capture shooting)	62
Using flash (flash photography)	64
Focus lock	66
Using the LED illuminator	67
Turning the LED illuminator on	67
To turn the LED illuminator off	67
Live Control	69
Settings accessible via Live Control	69
Available settings	69
Processing options (Picture Mode)	71

Picture mode options.	71
Using [Partial Color].	73
Changing ISO sensitivity (ISO Sensitivity).	74
Adjusting color (white balance).	75
One Touch WB.	77
Selecting a focus mode (AF mode).	78
Setting the aspect ratio.	79
Photo file and image size options (📷 Image quality).	80
Frame size, rate, and compression (🎞️ Movie Quality).	82
Available movie quality options.	82
Reducing camera shake (Image stabilizer).	84
Adjusting flash output (Flash intensity control).	85
Choosing how the camera measures brightness (Metering).	86
Automatic face detection (Face priority).	87
Using optional accessories (Accessory).	88
Playback.	89
Information display during playback.	89
Playback image information.	89
Switching the information display.	91
Viewing photographs and movies.	92
Viewing still pictures.	92
Viewing movies.	93
Finding pictures quickly (Index and Calendar Playback).	94
Zooming in (Close-up Playback).	95
Scrolling playback of panoramas.	96
Selecting multiple pictures (Share Order Selected, 🗑️, Erase Selected).	97
Deleting pictures (Erase).	98
Using functions during playback.	99
Playing back voice memos (Play 🎵) when the associated image is displayed.	101
Retouching pictures (RAW Data Edit/JPEG Edit).	102
Retouching RAW Pictures (RAW Data Edit).	102
Retouching JPEG Pictures (JPEG Edit).	103

Editing movies (Movie Edit)	105
Creating movie stills (In-Movie Image Capture).	105
Trimming movies (Movie Trimming).	105
Selecting pictures for sharing (Share Order).	107
Protecting Pictures (On).	108
Adding audio to pictures (🎤).	109
Rotating pictures (Rotate).	110
Playback images automatically (📺).	111
Combining pictures (Image Overlay).	112
Print order (DPOF).	113
Creating a print order.	113
Removing all or selected pictures from the print order.	114
Deleting pictures (Erase).	116
Menu Functions.	117
Basic menu operations.	117
Using Shooting Menu 1/Shooting Menu 2.	120
Shooting Menus 1 and 2.	120
Restoring Default Settings (Reset).	121
Saving Settings (Assign to Custom Mode).	122
Processing options (Picture Mode).	123
Selecting the focusing area (AF Area).	125
Setting the AF target (Area).	125
Continuously focusing on moving subjects (Tracking).	125
Shooting automatically with a fixed interval (Interval Shooting).	127
Varying focus little by little over a series of pictures (Focus BKT).	130
Increasing depth of field (Focus Stacking Settings).	131
Date stamps (Date Stamp).	132
Picture + Sound.	133
Using the Video Menu.	134
The Video Menu.	134
Using the Playback Menu.	135
The Playback Menu.	135

Automatically Rotating Portrait-Orientation Pictures for Playback ()	136
Removing Protection from All Pictures (Reset Protect)	137
Cancelling a share order (Reset share Order)	138
Using the Setup Menu.	139
The Setup Menu	139
Formatting the card (Card Setup)	141
Deleting all images (Card Setup)	142
Selecting a language	143
Using the Custom Menus.	144
The Custom Menus	144
A AF/MF	145
B Disp/  /PC	146
C Exp/ISO	147
D  Custom	148
E  /WB/Color	149
F Record	151
G Field Sensor	153
H  Utility	154
Assist Manual Focus (MF Assist)	155
Adding information displays using the INFO button ( /Info Settings)	156
I Info (Playback information displays)	156
LV-Info (Shooting information displays)	157
S Settings (Index/calendar display)	158
Viewing camera images on TV (HDMI)	159
Combinations of JPEG image sizes and compression rates ( Set)	161
Using the Construction Menus.	162
Construction Menu	162
Cautions	163
Displaying the Construction Menu	164
[Construction] in SCN mode	165
Configuring an image size for the Construction Menu	167

Configuring settings from Image quality for still pictures.	167
Configuring settings from the Shooting Menu (Easy CALS).	167
[Displayed Grid] in the Construction Menu.	169
Connecting the Camera to External Devices.	170
Connecting to External Devices.	170
Cautions for the use of Wi-Fi and Bluetooth ® functions.	171
Disabling the Camera's Wireless Functions.	172
Connecting the Camera to a Smartphone.	173
Connecting to Smartphones.	173
Pairing the Camera and Smartphone.	174
Wireless Connection Standby Setting for When the Camera Is On.	176
Transferring images to a smartphone.	177
Shooting remotely with a smartphone (Live View).	178
Shooting remotely with a smartphone (Remote Shutter).	179
Resetting wireless LAN/ Bluetooth ® settings.	180
Changing the password.	181
Connecting the Camera to a Computer.	182
Connecting the Camera to a Computer.	182
Copying Pictures to a Computer.	183
Installing the PC software.	184
Using the Remote Control.	185
Names of parts.	185
Connecting the camera and remote control.	186
Wireless connection.	186
Deleting pairing.	187
Shooting from the remote control.	188
Data transfer indicator of the remote control.	189
MAC address of the remote control.	190
Precautions for using the remote control.	191
Connecting to TVs or External Displays via HDMI.	192
Connecting the Camera to TVs or External Displays (HDMI).	192
Viewing Pictures on a TV (HDMI).	193

HDMI Output	193
Connecting the Camera to a TV.	195
Operating the camera using a TV remote control.	196
Using Field Sensor Data.	198
Field Sensor.	198
GPS and other data displays.	198
GPS: Precautions for use.	199
GPS function, electronic compass.	200
Before using GPS function (A-GPS data).	201
Updating the A-GPS data using a smartphone.	201
Updating the A-GPS data using a PC.	201
Using GPS.	202
Recording and Saving Logs.	203
Recording logs.	203
Saving logs.	203
Using Buffered and Saved Logs.	204
Things you can do with the designated app, OM Image Share.	204
Viewing Location Data.	205
Location data displays.	205
Shooting Modes and Default Settings.	206
List of configurable shooting modes.	206
Default Settings.	216
Direct Button.	217
Live Control.	218
 Shooting Menu.	219
 Video Menu.	221
 Playback Menu.	222
 Custom Menus.	223
 Setup Menu.	226
Memory Card Capacity.	227
Number of still pictures.	227
Memory card capacity: movies.	229

Cautions	231
Water and shock resistance	231
Using the camera underwater	232
Before using the camera underwater	232
When using the camera underwater	232
After using the camera underwater	232
Storage and maintenance	233
Other cautions	233
Batteries	234
Using your USB-AC adapter abroad	235
Information	236
Using Separately Sold Accessories	236
Attaching optional silicone jackets	236
Taking pictures with the Wireless RC Flash System	236
Optional accessories	237
Cleaning and storing the camera	242
Cleaning the camera	242
Storage	243
Pixel Mapping - Checking the image processing functions	243
Shooting tips and information	244
The camera does not turn on even when a battery is loaded	244
A dialog prompting you to choose a language is displayed	244
No picture is taken when the shutter button is pressed	245
The date and time have not been set	246
Set functions are restored to their factory default settings	246
Some settings are unavailable	247
Pictures are grainy	247
Pictures are "washed out"	247
Light appears in the picture	247
Unknown bright dot(s) appear on the subject in the picture taken	247
The lens is cloudy or the monitor is hard to read	248
Movies do not play back smoothly when viewed on a TV	248

The heading is not correct.	248
Functions that cannot be selected from menus.	248
Only the subject is displayed and no information is shown.	248
Error codes.	249
Specifications.	253
Camera.	253
Lithium-ion battery.	257
SAFETY PRECAUTIONS.	258
SAFETY PRECAUTIONS.	258
General Precautions.	258
⚠ WARNING.	259
⚠ CAUTION.	261
⚠ NOTICE.	261
Trademarks.	264

Introduction

Before You Begin

Read and Follow Safety Precautions

To prevent incorrect operations that may result in fire or other damage to property or harm to yourself or to others, read the entirety of [“SAFETY PRECAUTIONS” \(P.258\)](#) before using the camera.

While using the camera, consult this manual to ensure safe and correct operation. Be sure to keep the manual in a safe place after reading it.

Our company will not be held liable for violations of local regulations arising from use of this product outside the country or region of purchase.

Wireless LAN, Bluetooth[®], and GPS

The camera features built-in wireless LAN, **Bluetooth[®]**, and GPS. Use of these features outside the country or region of purchase may violate local wireless regulations. Be sure to check with local authorities before using these features. Our company will not be held liable for the user’s failure to comply with local regulations.

Disable wireless LAN, **Bluetooth[®]**, and GPS in areas where their use is prohibited.  [“Disabling the Camera’s Wireless Functions” \(P.172\)](#), [“GPS: Precautions for use” \(P.199\)](#)

User Registration

Be sure to register your purchase. Visit our website for information on registering your products.

Installing PC Software/Apps

OM Workspace

This computer application is used to download and view photos and movies recorded with the camera. It can also be used to update the camera firmware. The software can be downloaded from our website. Be prepared to provide the camera serial number when downloading the software.



OM Image Share

Download pictures marked for sharing to your smartphone. You can also operate the camera remotely and take pictures from your smartphone. Visit our website for information about the application.

About This Manual

How to find what you want to know





You can use the following methods to find what you want to know in this manual.

Search method	Where to look
Search based on what you want to do	 "Table of Contents"
Search based on names of buttons and parts of the camera	 "Names of parts" (P.15)
Search based on menus and terms displayed on the monitor	 "Default Settings" (P.216)

How to read this manual

Symbols in this manual

The following symbols are used throughout this manual.

	Indicates an operation performed using the front dial (a).
	Indicates an operation performed by pressing the up, down, left, and right arrow buttons on the arrow pad (b).
	Indicates cautions and limitations.
	Indicates tips and other helpful information for using the camera.
	Indicates references to other pages in this manual.

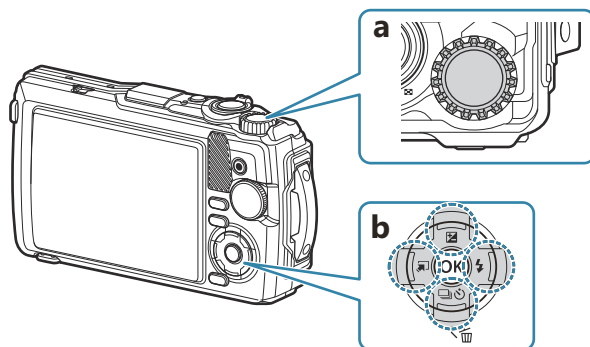

Names of parts

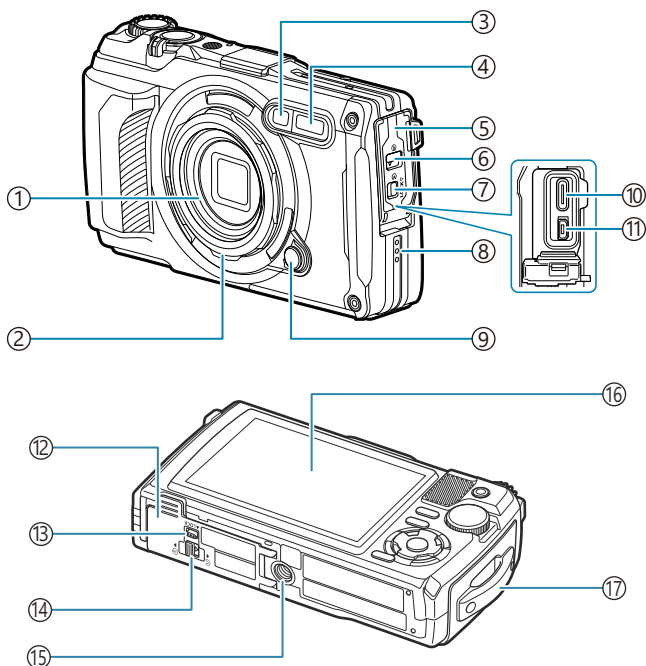

- ① Lens
- ② Lens ring (removable) (P.239)
- ③ Self-timer lamp/LED illuminator/AF illuminator (P.60, P.67, P.145)
- ④ Internal flash (P.64)
- ⑤ Connector cover (P.23)
- ⑥ Connector cover lock (P.23)
- ⑦ Lock knob (P.23)
- ⑧ Speaker
- ⑨ Lens ring release button (P.239)
- ⑩ USB connector (Type-C) (P.23, P.182)
- ⑪ HDMI connector (Type-D) (P.159)
- ⑫ Battery/card compartment cover (P.19)
- ⑬ Lock knob (P.19)
- ⑭ Battery/card compartment cover lock (P.19)
- ⑮ Tripod socket
- ⑯ Monitor (P.31, P.89, P.154)
- ⑰ Strap eyelet (P.18)

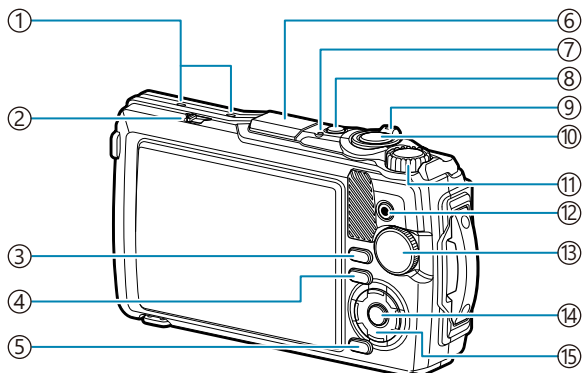

- ① Stereo microphone (P.109)
- ② LOG switch (P.203)
- ③ **INFO** button (P.33, P.91, P.67)
- ④ (playback) button (P.92)
- ⑤ **MENU** / Wi-Fi button (P.117)
- ⑥ GPS antenna (P.202)
- ⑦ Indicator lamp (P.23, P.203)
- ⑧ **ON/OFF** button (P.27)
- ⑨ Zoom lever (P.37, P.96, P.94, P.95)
- ⑩ Shutter button (P.35)
- ⑪ Control dial (P.92)
- ⑫ / button (P.54, P.97)
- ⑬ Mode dial (P.35)
- ⑭ **OK** button (P.69, P.92, P.117)
- ⑮ Arrow pad (P.57)
 - / (exposure compensation) button (P.58)
 - / (sequential shooting/self-timer) button / (erase) button (P.60, P.98)
 - / (mode function) button (P.49, P.51)
 - / (Flash) button (P.64)

Preparation

Unpacking the Box Contents

At purchase, the package contains the camera and the following accessories.
If anything is missing or damaged, contact the dealer from whom you purchased the camera.

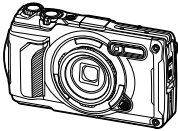

Camera
(with removable lens ring)

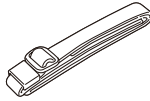

Strap

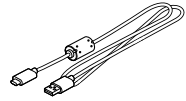

USB cable CB-USB14



Lithium-ion battery LI-92B



Basic Manual

- Warranty Card
- Maintaining Water Resistance

ⓘ The battery will not be fully charged at the time of purchase. Charge the battery before use ([P.23](#)).

Attaching the Strap

1. Pass the end of the strap through the strap eyelet on the camera and back through the keeper loop.

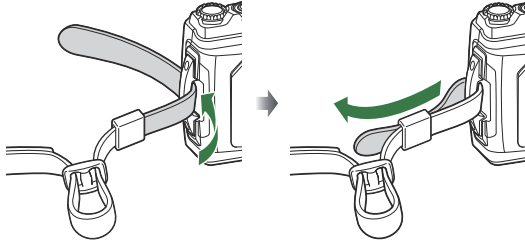

2. Pass the end of the strap through the buckle and tighten as shown.

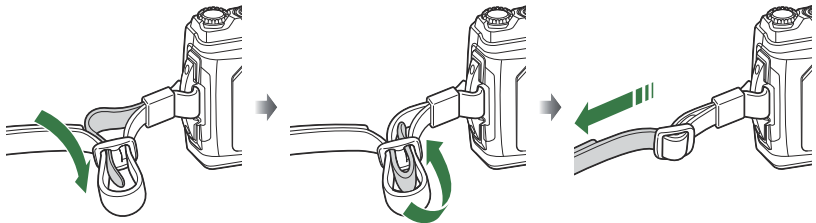

- After attaching the strap, pull on it firmly to ensure that it will not come loose.

Inserting and Removing the Battery and Card

In this manual, all storage devices are referred to as “cards”. The following types of SD cards (commercially available) can be used with this camera: SD, SDHC, and SDXC.

Cards must be formatted with this camera before first use or after being used with other cameras or computers. 🗨️ “[Formatting the card \(Card Setup\)](#)” (P.141)

Inserting the battery and card

1. Open the battery/card compartment cover.

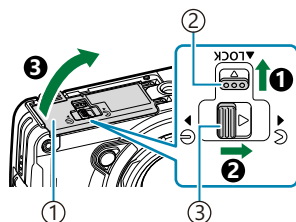

- ① Battery/card compartment cover
- ② Lock knob
- ③ Battery/card compartment cover open/close knob

2. Insert the battery.

- Use only LI-92B batteries (P.17).
- Insert the battery as illustrated with the ⚡ mark toward the battery lock knob.
- If you insert the battery in the wrong direction, the camera will not turn on. Be sure to insert it in the correct direction.

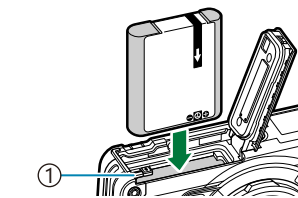

- ① Battery lock knob

🗨️ It is recommended to set aside a backup battery for prolonged shooting in case the battery in use drains.

🗨️ See also “[Batteries](#)” (P.234).

- 3.** Insert the card.
- Slide the card in until it is locked into place.

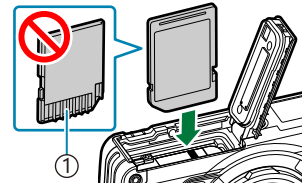

① Terminal area

⚠ Do not forcibly insert a damaged or deformed card. Doing so may damage the card slot.

- 4.** Close the battery/card compartment cover.
- While holding the battery/card compartment cover in the direction indicated by **1**, slide the open/close knob of the battery/card compartment cover and the lock knob to lock the cover (**2**, **3**).
 - When using the camera, be sure to close and lock the battery/card compartment cover.

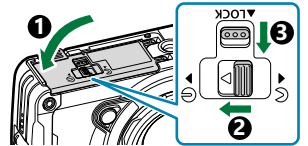

Removing the battery

Turn off the camera before opening or closing the battery/card compartment cover. To remove the battery, first push the battery lock knob in the direction of the arrow, then remove it.

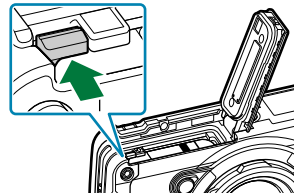

⚠ Do not remove the battery while the card write indicator is displayed.



① Card write indicator

⚠ Contact an authorized distributor or service center if you are unable to remove the battery. Do not forcibly remove the battery.

Removing the card

Press the inserted card lightly to eject it. Pull out the card.

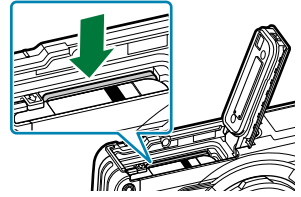

ⓘ Do not remove the card while the card write indicator is displayed (P.20).

Usable cards

The following types of SD cards (commercially available) can be used with this camera: SD, SDHC, and SDXC. For the latest information, please visit our website.



SD card write protect switch

The SD card body has a write protect switch. Setting the switch to "LOCK" prevents data being written to the card. Return the switch to the unlock position enable writing.



ⓘ The data in the card will not be erased completely even after formatting the card or deleting the data. When discarding, destroy the card to prevent leakage of personal information.

File storage locations

Data on the card are stored in the following folders:

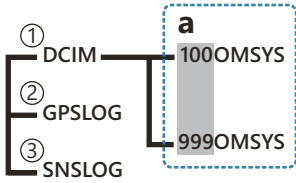

- ① **DCIM:** Images are stored in the sub-folders (a). Sub-folders are automatically numbered sequentially.
- ② **GPSLOG:** GPS logs are stored in this folder.
- ③ **SNSLOG:** Sensor logs are stored in this folder.

Charging the Battery

- ⚠ The battery will not be fully charged at the time of purchase. Charge the battery before use.
- ⚠ The ambient temperature for charging is 0°C to 40°C.
- ⚠ The camera can be charged using the following methods.
 - Using the F-5AC (sold separately) (P.23)
 - Connecting the camera to a computer (P.182)
 - Using a commercially available USB device (P.25)

Charging the battery using an optional USB-AC adapter

1. Check that the battery is in the camera, and connect the USB cable and USB-AC adapter.

⚠ Do not use any USB cable other than the USB cable supplied with the camera (CB-USB14) or an optional USB cable (CB-USB11).

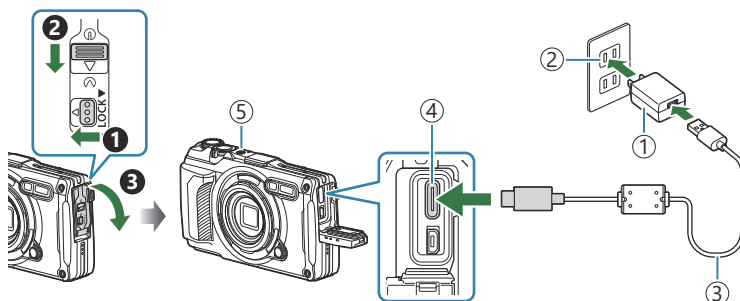

- ① USB-AC adapter F-5AC (sold separately)
- ② AC outlet
- ③ USB cable (supplied)
- ④ USB connector (Type-C)
- ⑤ Indicator lamp

- The menu will be displayed on the monitor.

2. Highlight **[Charge]** using the Δ ∇ buttons on the arrow pad and press the **OK** button.

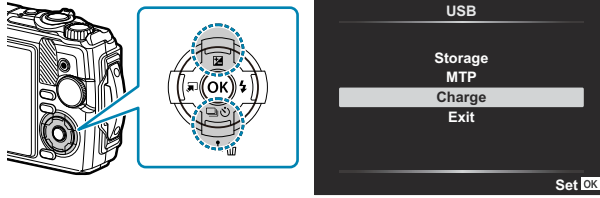

- The indicator lamp will light and charging will begin.
- The indicator lamp turns off when charging is complete.
- Charging takes about 3 hours. Charging times may increase at high ambient temperatures.

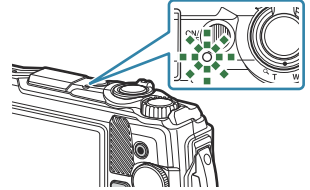

ⓘ Be sure to unplug the power plug of the USB-AC adapter from the wall outlet when charging is complete.

🔌 Use the USB-AC adapter for prolonged shooting. In that case, make sure that the battery is inserted into the camera and select **[Charge]** in the dialog displayed after the USB cable is connected.

Pressing the **ON/OFF** button after the monitor turns off turns the monitor back on, and pictures can be taken during the charging.

🔌 To charge the battery abroad, see [“Using your USB-AC adapter abroad” \(P.235\)](#).

ⓘ Never use any cable other than the supplied cable or a designated USB cable. Using another cable can cause smoking or burning.

ⓘ If the indicator lamp is not lit, reconnect the USB cable and USB-AC adapter to the camera.

🔌 A charger (UC-92: sold separately) can be used to charge the battery.

ⓘ Handling the USB-AC adapter

When cleaning the camera, unplug the USB-AC adapter from the power outlet. Cleaning the camera without unplugging the USB-AC adapter may cause electric shock or injury.

When to charge the batteries

If the camera displays the message shown in the illustration, charge the battery.

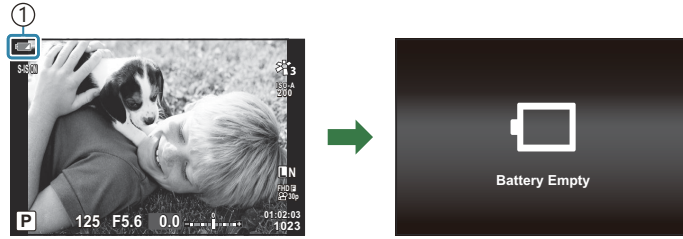

① Flashes in red

Charging with a USB device

The battery inside the camera can be charged by connecting the camera to a commercially available USB device using a USB cable.

1. After confirming that the battery is inside the camera, connect the camera to a USB device using a USB cable.
 - The menu will be displayed on the monitor.

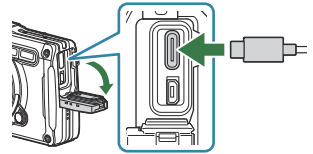

2. Highlight **[Charge]** using the Δ ∇ buttons on the arrow pad and press the **OK** button.

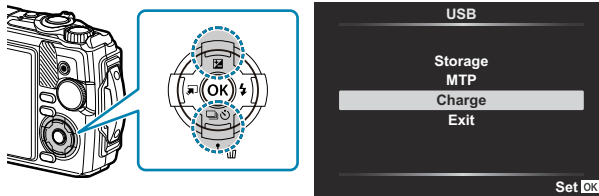

- The indicator lamp will be lit while charging is in progress. Charging time varies depending on the output specifications of the connected USB device. The indicator lamp turns off when charging is complete.

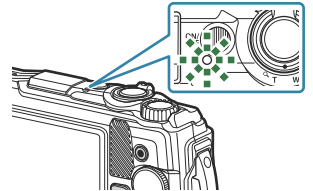

⌚ If the indicator lamp is not lit, reconnect the USB cable and USB-AC adapter to the camera.

⚠ Charging time varies greatly depending on the types of USB devices. USB devices that support an output of 7.5 W (5 V/1.5 A) are recommended. Some USB devices may not be used to charge camera batteries via USB. For details, refer to the documentation provided with the USB device.

Turning the Camera On

1. Press the **ON/OFF** button to turn on the camera.
 - When the camera is turned on, the monitor will turn on.
 - To turn the camera off, press the **ON/OFF** button again.

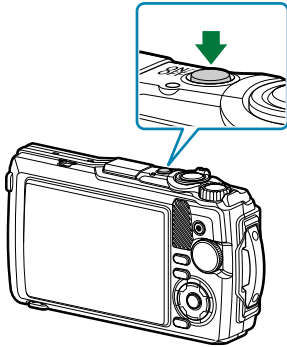

Battery level indicator



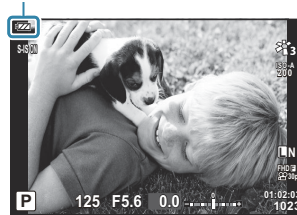

The battery level is displayed on a battery icon.

- (green): The camera is ready to shoot.
- (green): The battery is not full.
- (blinks red): Charge the battery.



Sleep Mode

If no controls are used for a set period, the camera will automatically go into standby to reduce the drain on the batteries. This is referred to as “sleep mode”.

- When the camera enters sleep mode, the monitor will turn off and operation will be suspended. Pressing the shutter or  button reactivates the camera.
 - If no operations are performed for five minutes after the camera enters sleep mode, the camera will turn off automatically. The camera can be reactivated by turning it on again.
- ⓘ The delay before the camera enters sleep mode can be selected in the  Custom Menu. At default settings, the camera will enter sleep mode after one minute.   Custom Menu  > **[Sleep]** (P.154)

Initial Setup

After turning the camera on for the first time, perform the initial setup by choosing a language and setting the camera clock.

- ⓘ File names are created based on date and time information. Be sure to set the correct date and time before using the camera. Some functions cannot be used if the date and time have not been set.

1. Press the **OK** button when the initial setup dialog prompting you to choose a language is displayed.

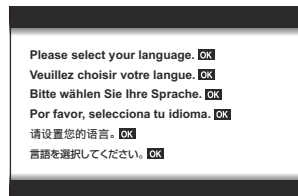

2. Highlight the desired language using the control dial or the $\Delta \nabla \triangleleft \triangleright$ buttons.



3. Press the **OK** button when the desired language is highlighted.



- If you press the shutter button before pressing the **OK** button, the camera will exit to shooting mode and no language will be selected. You can perform the initial setup by turning the camera off and then on again to display the initial setup dialog and repeating the process from Step 1.
- The language can be changed at any time from the menu. 🖱️ [“What to Do if You Can’t Read the Display” \(P.30\)](#)

4. Set the date, time, and date format.

- Use the ◀▶ buttons to highlight items.
- Use the ▲▼ buttons or control dial to change the highlighted item.
- The time is displayed using a 24-hour clock.

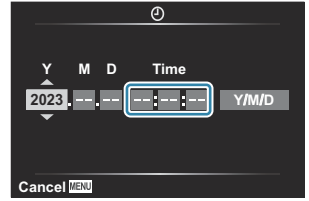

- The clock can be adjusted at any time from the menu. 🖱️ [Setup Menu > \[🕒 Settings\]](#) (P.139)

5. Press the **OK** button.

6. Highlight a time zone using the ▲▼ buttons and press the **OK** button.

- Press the **INFO** button to enable or disable daylight saving time.

7. Press the **OK** button to save changes and exit.

🔗 Date and time information is recorded on the card together with the images.

🔗 If the battery is removed and left outside of the camera for a while, the date and time may be reset.

If this happens, set the date and time from the menu. 🖱️ [Setup Menu > \[🕒 Settings\]](#) (P.139)

🔗 You may also need to adjust the frame rate before shooting movies. 🖱️ ["Frame size, rate, and compression \(📺 Movie Quality\)"](#) (P.82)

What to Do If You Can't Read the Display

If you see unfamiliar characters or words in other languages, you may not have selected the language you intended. Follow the steps below to choose another language.

1. Press the **MENU** button to view the menus.

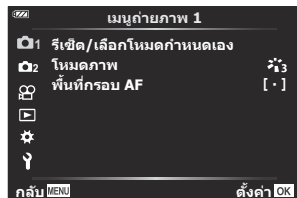
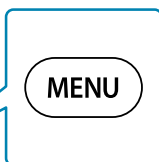
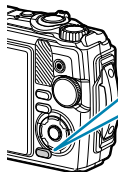

2. Highlight the **Y** (Setup Menu) tab using the Δ ∇ buttons and press the **OK** button.

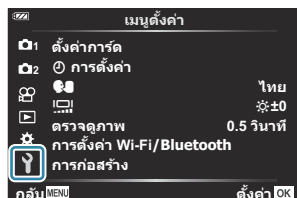
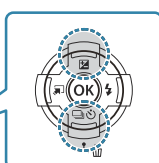
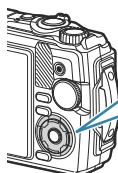

3. Highlight **[Thai]** using the Δ ∇ buttons and press the **OK** button.

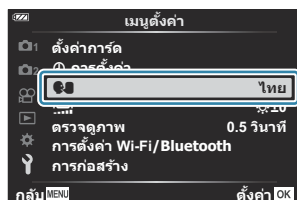

4. Highlight the desired language using the Δ ∇ \triangleleft \triangleright buttons and press the **OK** button.



Shooting

Information displays while shooting

Monitor display during still photography

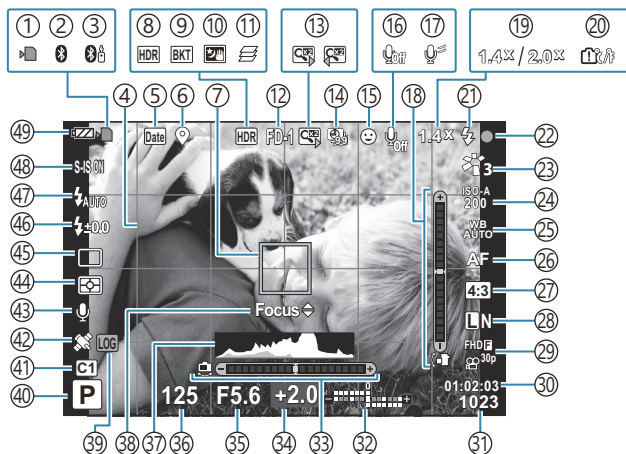

Monitor display during movie mode

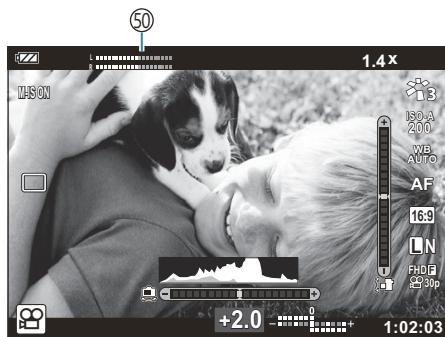

- ① Card write indicator (P.20, P.21)
- ② Active Bluetooth connection (P.174)
- ③ Active remote control connection (P.186)
- ④ Grid (P.146)
- ⑤ Date stamps (P.132)
- ⑥ Recording location information (P.203)
- ⑦ AF target (P.35, P.125)
- ⑧ HDR (P.43, P.51)
- ⑨ Bracketing (P.130)
- ⑩ Handheld starlight (P.43)
- ⑪ Focus stacking (P.49)
- ⑫ Accessory (P.88, P.237)
- ⑬ Digital teleconverter ¹ (P.59)
- ⑭ Interval/time lapse shooting (P.127)
- ⑮ Face priority (P.87)
- ⑯ Movie sound recording (P.54, P.134)
- ⑰ Wind noise reduction (P.134)
- ⑱ Level gauge (tilt) (P.33, P.157)
- ⑲ Optical zoom ratio/magnification ¹ (P.37, P.49)
- ⑳ Internal temperature warning (P.249)
- ㉑ Flash (blinks: charging in progress, lights up: charging completed) (P.64)
- ㉒ AF confirmation mark (P.35)
- ㉓ Picture Mode (P.71, P.123)
- ㉔ ISO sensitivity (P.74)
- ㉕ White balance (P.75)
- ㉖ AF mode (P.78)
- ㉗ Aspect ratio (P.79)
- ㉘ Image quality (still images) (P.80)
- ㉙ Image quality (movie) (P.82)
- ㉚ Available recording time (P.229)
- ㉛ Number of storable still pictures (P.227)
- ㉜ Top: Flash intensity control (P.85)
Bottom: Exposure compensation (P.58)
- ㉝ Level gauge (horizon) (P.33, P.157)
- ㉞ Exposure compensation (P.58)
- ㉟ Aperture value (P.39, P.41)
- ㊱ Shutter speed (P.39, P.41)
- ㊲ Histogram (P.33, P.157)
- ㊳ AF fine-tuning guide (P.66, P.78)
- ㊴ LOG icon/warning (P.203, P.249)
- ㊵ Shooting mode (P.35)
- ㊶ Custom modes (P.52, P.122)
- ㊷ GPS icon (P.202)
- ㊸ Picture + Sound (P.133)
- ㊹ Metering mode (P.86)
- ㊺ Sequential/self-timer shooting (P.60)
- ㊻ Flash intensity control (P.85)
- ㊼ Flash mode (P.64)
- ㊽ Image stabilizer (P.84)
- ㊾ Battery level (P.27)
- ㊿ Recording level meter (P.55)

¹ Displayed at all times if [ **Microscope Control**] (P.49) is in use.

Switching the information display

You can switch the information displayed in the monitor during shooting using the **INFO** button.

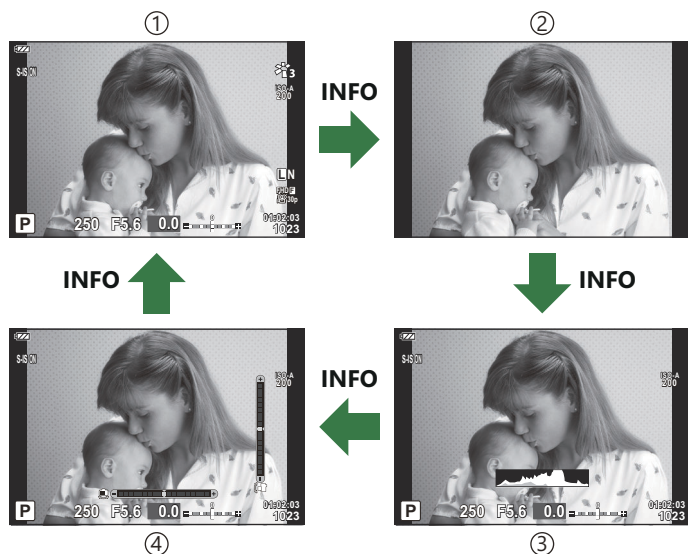
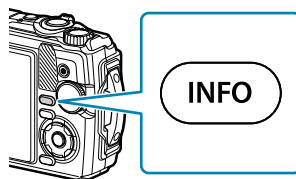

① Basic Information ¹

② Image only

③ Histogram display (Custom1)

④ Level gauge display (Custom2)

¹ Not displayed in  mode (movie mode) unless recording is in progress.

- You can change Custom1 and Custom2 settings.  [\[INFO/Info Settings\] > \[LV-Info\] \(P.157\)](#)
- The information display screens can be switched in either direction by rotating the control dial while pressing the **INFO** button.

Histogram display

A histogram showing the distribution of brightness in the image is displayed. The horizontal axis gives the brightness, the vertical axis the number of pixels of each brightness in the image. During shooting, overexposure is indicated in red, underexposure in blue, and the range metered using spot metering in green.

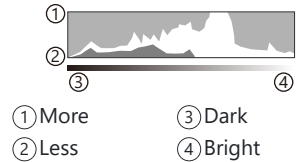



Level gauge display



The orientation of the camera is indicated. The “tilt” direction is indicated on the vertical bar and the “horizon” direction on the horizontal bar. The camera is level and plumb when the bars turn green.

- Use the indicators on the level gauge as a guide.
- If there are any errors in the display, perform Level Adjust ([P.154](#)).

Shooting Still Pictures

Shooting modes

	AUTO (P.38)
P	Program AE (P.39)
A	Aperture-priority AE (P.41)
SCN	Scene (P.43)
	Microscope (P.49)
	Underwater (P.51)
C1	Custom (P.52)
C2	

 For information on the  position on the mode dial, see “Recording movies in movie mode ( mode)” (P.55).

1. Rotate the mode dial to set the mode you wish to use.

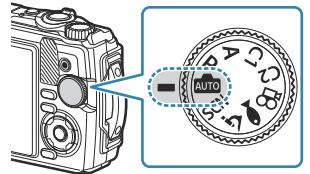

2. Frame the shot.

⚠ Be careful that your fingers or the camera strap do not obstruct the lens or AF illuminator.

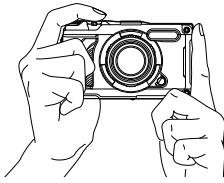

Landscape position

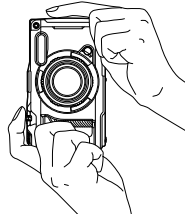

Portrait position

3. Adjust the focus.

- Position the AF frame over your subject.

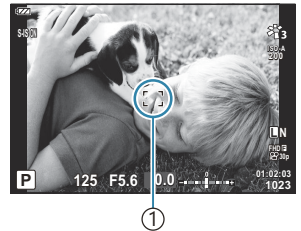

① AF frame

- Lightly press the shutter button down to the first position (press the shutter button halfway).



- The AF confirmation mark (●) will be displayed, and a green frame (AF target) will be displayed in the focus location.

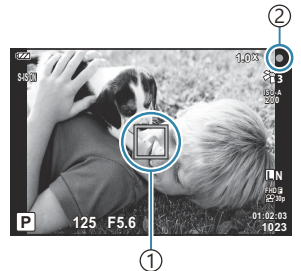

① AF target

② AF confirmation mark

⚠ If the camera is unable to focus, the AF confirmation mark will flash (P.245).

4. Release the shutter.

- Press the shutter button the rest of the way down (fully).
- The camera will release the shutter and take a picture.
- The shot image will be displayed on the monitor.



Press the shutter button all the way down.

Using the zoom

Zoom in to photograph distant objects or zoom out to increase the area visible in the frame. Zoom can be adjusted using the zoom lever.

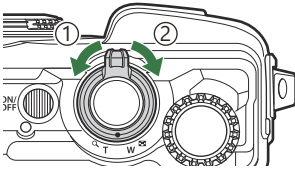

① Wide (W) side





② Telephoto (T) side

Letting the camera choose the settings (AUTO mode)

The camera adjusts settings to suit the scene. All you have to do is press the shutter button.

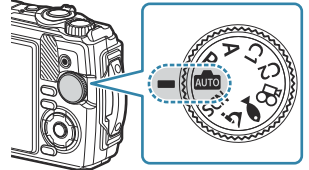
1. Rotate the mode dial to .



- In auto mode, the camera automatically selects the scene mode option appropriate to your subject when you press the shutter button halfway. Once the selection has been made, the  icon in the bottom left corner of the display will be replaced by the icon for the chosen scene.

2. Release the shutter.

Letting the camera choose aperture and shutter speed (P: Program AE)

The camera chooses the optimal aperture and shutter speed according to subject brightness.

1. Rotate the mode dial to **P**.

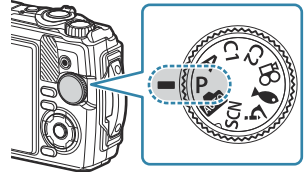





2. Focus and check the display.

- The shutter speed and aperture chosen by the camera are displayed.





- ① Exposure mode
- ② Shutter speed
- ③ Aperture
- ④ Exposure compensation amount

- Exposure compensation ([P.58](#)) can be adjusted by rotating the control dial or by pressing the  () button and then using  .

3. Release the shutter.

If the subject is too dark or too bright

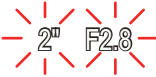
If the camera is unable to achieve optimal exposure, the shutter speed and aperture displays will flash as shown.

Display	Problem/solution
<p data-bbox="87 316 505 368">Large aperture (low f/-number)/slow shutter speed</p> 	<p data-bbox="583 352 804 376">The subject is too dark.</p> <ul data-bbox="594 384 703 408" style="list-style-type: none"><li data-bbox="594 384 703 408">• Use flash.
<p data-bbox="87 488 505 541">Small aperture (high f/-number)/fast shutter speed</p> 	<p data-bbox="583 512 818 536">The subject is too bright.</p> <ul data-bbox="594 544 1001 600" style="list-style-type: none"><li data-bbox="594 544 1001 600">• The limits of the camera metering system have been exceeded.

🔗 If ISO sensitivity is not set to **[AUTO]**, optimal exposure may be achieved by changing the setting.

👉 ["Changing ISO sensitivity \(ISO Sensitivity\)" \(P.74\)](#)

Choosing aperture (A: Aperture-Priority AE)

By choosing the aperture value (F value) in this mode, the camera will automatically set the shutter speed for optimal exposure according to subject brightness. Lower aperture values (larger apertures) reduce the depth of the area that appears to be in focus (depth of field), blurring the background. Higher aperture values (smaller apertures) increase the depth of the area that appears to be in focus in front of and behind the subject.

1. Rotate the mode dial to **A**.

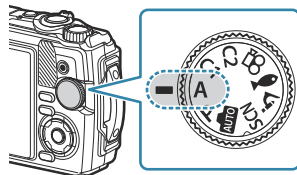

2. Rotate the control dial to adjust exposure compensation.





① Aperture

- The camera will automatically select the optimal shutter speed, which will appear in the display.
- After pressing the  (Δ) button, you can adjust exposure compensation (P.58) by using the control dial or $\triangleleft \triangleright$.

3. Release the shutter.

If the subject is too dark or too bright

If the camera is unable to achieve optimal exposure, the shutter-speed display will flash as shown.

Display	Problem/solution
Slow shutter speed  1" F5.6	The problem is caused by underexposure. <ul style="list-style-type: none">• Choose a lower aperture value.
Fast shutter speed  2000 F5.6	The problem is caused by overexposure. <ul style="list-style-type: none">• Choose a higher aperture value.

🔗 If ISO sensitivity is not set to **[AUTO]**, optimal exposure may be achieved by changing the setting.

👉 [Changing ISO sensitivity \(ISO Sensitivity\) \(P.74\)](#)





Shooting in scene mode (SCN mode)

The camera automatically optimizes settings according to the subject or scene.



- The procedures for using **[Live Composite]** and **[Panorama]** differ from the other scene modes. For more information, see "**[Live Composite]: Live composite photography**" (P.46) and "**[Panorama]: Shooting a panorama**" (P.47).



Types of scene modes

People



	Portrait	Suitable for shooting portraits. Skin texture is brought out.
	e-Portrait	Smooths out skin tones and texture. The camera records two pictures: one with the effect applied and one without.
	Portrait + Landscape	Suitable for portraits featuring a landscape in the background. Blues, greens, and skin tones are captured beautifully.
	Portrait + Nightscape	Suitable for shooting portraits against a night view backdrop. We recommend that you use a tripod and take pictures remotely with either OM Image Share or an optional remote control (P.178, P.179, P.188).
	Children	Suitable for photographs of children and other active subjects. The camera will take multiple photos while the shutter button is pressed.

Nightscapes





	Nightscape	Suitable for shooting night scenes using a tripod. We recommend that you use a tripod and take pictures remotely with either OM Image Share or an optional remote control (P.178, P.179, P.188).
	Portrait + Nightscape	Suitable for shooting portraits against a night view backdrop. We recommend that you use a tripod and take pictures remotely with either OM Image Share or an optional remote control (P.178, P.179, P.188).

	Handheld Starlight	Suitable for shooting night scenes without a tripod. Reduces blur when shooting low light/illuminated scenes. The camera makes eight exposures and combines them into a single photograph.
	Fireworks	Suitable for shooting fireworks at night. We recommend that you use a tripod and take pictures remotely with either OM Image Share or an optional remote control (P.178, P.179, P.188).
	Live Composite	<p>The camera automatically shoots multiple images, takes only areas that have become bright, and composites them into a single image. With normal long exposure, images of light traces such as star trails with bright buildings tend to become too bright. This mode allows you to capture such scenes without over exposure while checking the progress. We recommend that you use a tripod and take pictures remotely with either OM Image Share or an optional remote control (P.178, P.179, P.188).</p> <ul style="list-style-type: none"> • For information on taking photos using this feature, see “[Live Composite]: Live composite photography” (P.46).

Motion





	Sport	Suitable for shooting fast action. The camera will take multiple photos while the shutter button is pressed.
	Children	Suitable for photographs of children and other active subjects. The camera will take multiple photos while the shutter button is pressed.

Scenery

	Landscape	Suitable for shooting landscapes.
	Sunset	Suitable for shooting sunsets.
	Beach & Snow	Suitable for shooting at snow-capped mountains, sunny beaches, and other similar scenes.
	Panorama	<p>Shoot a series of images that are combined to create a panorama.</p> <ul style="list-style-type: none"> • For information on taking photos using this feature, see “[Panorama]: Shooting a panorama” (P.47).

	Backlight HDR	Suitable for high-contrast scenes. This mode captures multiple images and merges them into one, properly exposed image. When the shutter button is pressed, four photographs will be taken automatically. After shooting, the camera automatically combines the frames into a single image.
--	----------------------	---

Indoors

	Candlelight	Suitable for shooting candlelit scenes. Warm colors are preserved.
	Portrait	Suitable for shooting portraits. Skin texture is brought out.
	e-Portrait	Smooths out skin tones and texture. The camera records two pictures: one with the effect applied and one without.
	Children	Suitable for photographs of children and other active subjects. The camera will take multiple photos while the shutter button is pressed.
	Backlight HDR	Suitable for high-contrast scenes. This mode captures multiple images and merges them into one, properly exposed image. When the shutter button is pressed, four photographs will be taken automatically. After shooting, the camera automatically combines the frames into a single image.

 When **[Construction Menu]** (P.164) is set to **[On]**, the scene mode is specifically configured for shooting in construction sites (P.165).

 To maximize the benefits of the scene modes, some of the shooting function settings are disabled.

 Some time may be needed to record pictures taken using **[e-Portrait]**. In addition, when the image quality mode is **[RAW]**, the image is recorded in RAW+JPEG.

 **[Handheld Starlight]** pictures taken with **[RAW]** selected for image quality will be recorded in RAW+JPEG format, with the first frame recorded as a RAW image and the final composite as a JPEG image.

 **[Backlight HDR]** records HDR-processed images in JPEG format. When the image quality mode is set to **[RAW]**, the image is recorded in RAW+JPEG.

- Noise may be more noticeable in photos taken in conditions associated with slow shutter speeds.
- For best results, secure the camera in place by, for example, mounting it on a tripod.
- The image displayed on the monitor while shooting will differ from the HDR-processed image.
- The picture mode is fixed to **[Natural]** and the color space is fixed to **[sRGB]**.

1. Rotate the mode dial to **SCN**.

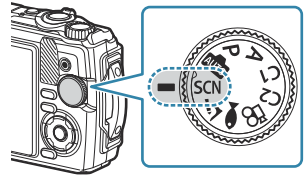

2. Use Δ ∇ \triangleleft \triangleright or the control dial to highlight a scene and press the **OK** button.



3. Highlight the desired scene mode using \triangleleft \triangleright or the control dial and press the **OK** button.
 - To return to the previous display, press the **MENU** button without pressing the **OK** button to select a scene mode.

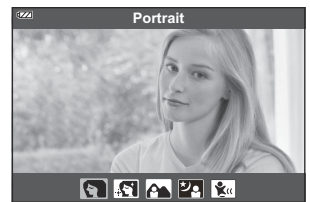

4. Release the shutter.
 - To choose a different scene, press the \square (\triangleleft) button.

[Live Composite]: Live composite photography

1. Rotate the mode dial to **SCN**.
2. Highlight [**Nightscapes**] using Δ ∇ \triangleleft \triangleright or the control dial and press the **OK** button.
3. Highlight [**Live Composite**] using \triangleleft \triangleright or the control dial and press the **OK** button.
4. Press the shutter button halfway to focus.
 - In order to stabilize the camera, we recommend that you secure the camera firmly in place using a tripod and take pictures remotely with either OM Image Share or an optional remote control ([P.178](#), [P.179](#), [P.188](#)).
 - If the focus indicator blinks, the camera is not in focus.

5. Press the shutter button all the way down to start shooting.
 - The camera configures the proper settings automatically and starts shooting.
 - After pressing the shutter button, there is a time lag until shooting starts.
 - The composite image will be displayed at regular intervals.

6. Press the shutter button again to stop shooting.
 - View the changing result in the monitor and press the shutter button to end shooting once the desired result is achieved.
 - The maximum recording length of one shot is 3 hours.

[Panorama]: Shooting a panorama

1. Rotate the mode dial to **SCN**.

2. Highlight [**Scenery**] using $\Delta \nabla \langle \triangleright$ or the control dial and press the **OK** button.

3. Highlight [**Panorama**] using $\langle \triangleright$ or the control dial and press the **OK** button.

4. Press the shutter button to shoot the first frame.

5. Pan the camera slowly to frame the second shot.
 - A target mark will be displayed.

6. Move the camera slowly so that the pointer and the target mark overlap. The camera releases the shutter automatically when the pointer and the target overlap.

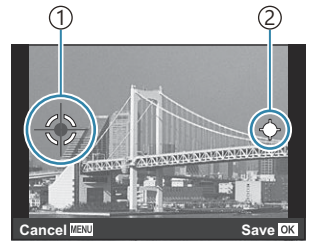

To combine images from left to right

- ① Target mark
- ② Pointer

- Press the **OK** button to combine only the two frames.

7. Repeat step 5 to take a third frame. The camera automatically combines the frames into a single panorama image.







- To cancel the panorama function, press the **MENU** button.

🔍 Focus, exposure, and other settings are fixed at the values in effect at the start of shooting.

🔍 If you press the **OK** button or press the shutter button again before panning the camera to move the target over the pointer, shooting will end and a panorama will be created from the frames shot to that point.



Shooting at very close range (mode)

Images can be taken from up to 1 cm away from the subject. In this mode, you can shoot images with a large depth of field and perform focus bracket shooting of a set number of images.

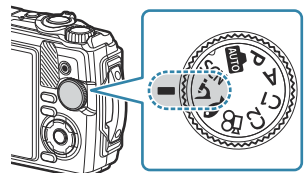

Sub mode	Description
 Microscope	Images can be taken from up to 1 cm away from the subject.
 Focus Stacking	<p>The camera shoots a number of images, automatically shifting the focus in each image. These can then be combined into a composite image with a large depth of field. Two images are recorded, the first frame and the composite image. The number of shots and the length of time the camera waits before shooting starts can be selected in [Focus Stacking Settings] (P.131).</p> <p>⌚ In some cases, it may not be possible to create a composite image due to shaking of the camera.</p>
 Focus Bracketing	In this mode, the camera shoots a number of images, automatically shifting the focus in each image. The number of images and shooting steps are set in [Focus BKT] (P.130) .
 Microscope Control	Optimized for close-ups with the subject magnified in the monitor. The magnification level when the shooting distance is 1 cm is displayed on the monitor. Press  to zoom in on the view through the lens (2× zoom). Press again for 4× zoom. Pressing  when 4× zoom is selected cancels zoom. At high magnification levels, the image may be grainy.

1. Rotate the mode dial to .







2. Highlight a secondary (“sub”) mode using   or the control dial and press the **OK** button.



3. Release the shutter.
- To take a series of shots at the same focus distance, use focus lock ([P.66](#)) or MF ([P.78](#)).
 - To choose a different scene, press the  (mode function) ( button).

Matching settings to underwater scenes (🐟 mode)

Underwater photographs can be shot with the appropriate settings only by selecting a sub mode according to the subject or the scene.

Sub mode	Description
 Underwater Snapshot	Optimized for underwater photography shot using natural light.
 Underwater Wide	Optimized for shooting underwater.
 Underwater Macro	Optimized for taking underwater shots close to subjects.
 Underwater Microscope	Suitable for shooting subjects under water from distances as close as 1 cm.
 Underwater HDR	Suitable for underwater scenes with high contrast. This mode captures multiple images and merges them into a single properly exposed image. This mode may not be suitable for shooting fast-moving subjects.

1. Rotate the mode dial to 🐟.

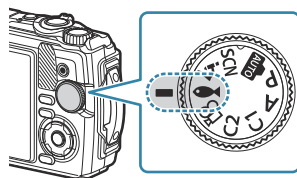

2. Highlight a secondary (“sub”) mode using ◀▶ or the control dial and press the **OK** button.



3. Release the shutter.

- To take a series of shots at the same focus distance, use focus lock (P.66) or MF (P.78).
- To choose a different scene, press the  (mode function) (◀) button.

Using Custom Modes (Custom Mode C1/C2)

Frequently-used settings and shooting modes can be saved as custom modes and recalled as needed by simply rotating the mode dial.

- Different settings can be stored in each of the two custom modes (**C1** and **C2**).
- At default settings, custom modes are equivalent to mode **P**.

Saving settings

1. Adjust camera settings as desired.
 - Rotate the mode dial to a position other than  (movie mode).
2. Press the **MENU** button to view the menus.

3. Highlight the  tab using the Δ ∇ \triangleleft buttons and press the **OK** button.

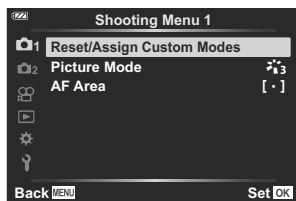

4. Highlight [**Reset/Assign Custom Modes**] and press the **OK** button.
5. Highlight [**Custom Mode C1**] or [**Custom Mode C2**] and press the **OK** button.
6. Highlight [**Set**] and press the **OK** button.
 - The [**Reset/Assign Custom Modes**] menu will be displayed again.
 - Any existing settings will be overwritten.
 - To restore default settings for the selected custom mode, highlight [**Reset**] and press the **OK** button.

Recalling settings

1. Rotate the mode dial to **C1** or **C2**.

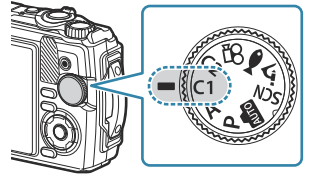



- The settings saved using **[Reset/Assign Custom Modes] > [Custom Mode C1]** or **[Custom Mode C2]** in Shooting Menu 1 will be recalled.

2. Release the shutter.

Recording movies

You can film movies using the camera's dedicated  (movie) mode or perform basic recording operations without ending still photography.

Movies are recorded using the  (movie) button.

Movie-related options and indicators can be displayed by rotating the mode dial to select  (movie) mode.

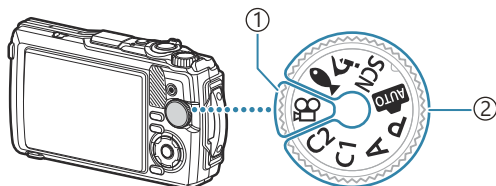

① (movie) mode

Select this mode if you will primarily be filming movies.

② **Still photography modes**

Select these modes to film movies during still photography.

 CMOS image sensors of the type used in the camera generate a “rolling shutter” effect that can cause distortion in pictures of moving objects. This distortion is a physical phenomenon that occurs in pictures of fast-moving subjects or if the camera is moved during shooting. It is particularly noticeable in pictures taken at long focal lengths.

Recording movies in photo shooting modes

1. Press the  button to begin recording.

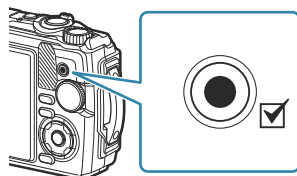

- The movie you are recording will be displayed on the monitor.

2. Press the  button again to stop recording.

⚠ The  button cannot be used to record movies in the following instances:

- While the shutter button is pressed halfway or while sequential, interval timer, live composite, or panorama photography is in progress

Recording movies in movie mode (mode)

1. Rotate the mode dial to .

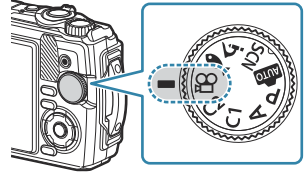

2. Press the  button to begin recording.

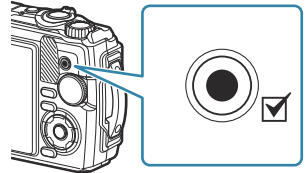

- Press the  button again to stop recording.

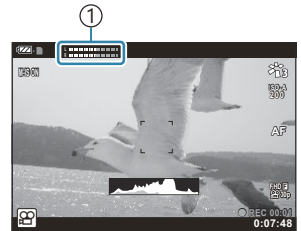

- During movie recording, you can check the recording volume on the recording level meter. The more the recording level meter extends in the red direction, the louder the recording volume.



① Recording level meter

- The recording volume can be adjusted in the  Movie Menu.  [\[Recording Volume\]](#) (P.134)

⚠ The camera does not beep when it focuses in movie mode.

Shooting Settings

Shooting settings

Shooting settings can be adjusted using any of the following:

Direct Buttons (P.57)

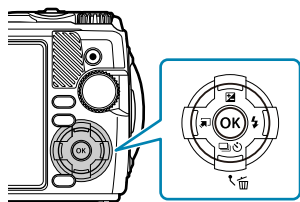

Frequently used functions are assigned to $\Delta \nabla \triangleleft \triangleright$. You can select the assigned function directly just by pressing the button. Some features may be unavailable depending on the shooting mode and camera settings.  [“List of configurable shooting modes” \(P.206\)](#)

Live Control (P.69)

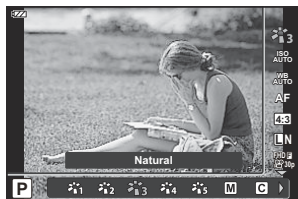

Adjust settings while previewing the results in the display. Some functions are not available in some shooting modes.  [“List of configurable shooting modes” \(P.206\)](#)

Menu (P.117)

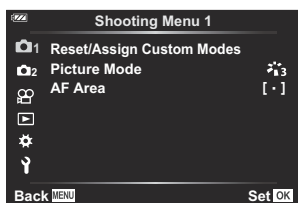

Access a wide variety of functions, including shooting, playback, time and date, and display settings.

Direct Buttons





Settings accessible via Direct Buttons

Frequently used functions are assigned to Δ ∇ \triangleleft \triangleright . You can select the assigned function directly by simply pressing the button.

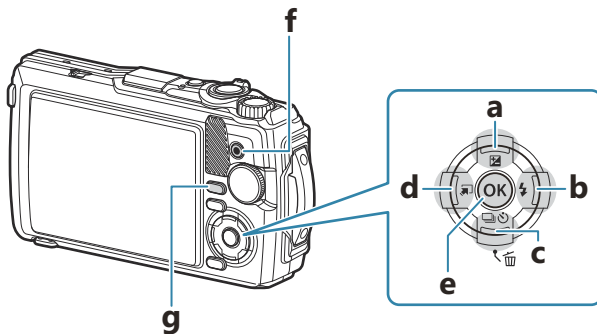
Some features may be unavailable depending on the shooting mode and camera settings.  "List of configurable shooting modes" (P.206)

The buttons to which functions can be assigned are listed below.



Direct Button		Assigned function
a	 button (Δ)	Exposure compensation (P.58)
b	 button (\triangleright)	Flash (P.64)
c	 button (∇)	Sequential shooting/self-timer (P.60)
d	 button (\triangleleft)	Mode function (P.43, P.49, P.51)
e	OK button	Live Control (P.69)
f	 button	Movie recording (P.54)
g	INFO button	Information display (P.33)

Controlling exposure (Exposure Compensation)







Select positive (“+”) values to make pictures brighter, and negative (“-”) values to make pictures darker. Exposure can be adjusted by ± 2.0 EV.



- ① Negative (-)
- ② No compensation (0)
- ③ Positive (+)



Adjusting Exposure Compensation

The method used varies with the shooting mode.



Exposure mode	Method
P / C1 / C2 /  /  / 	Rotate the control dial. or Press the  button (Δ) and then press $\triangleleft \triangleright$.
A	Press the  button (Δ), then rotate the control dial. or Press the  button (Δ), then press $\triangleleft \triangleright$.

- Exposure compensation is not available in  or **SCN** mode.

Zoom (digital teleconverter)



Zoom in on the center of the frame and record. In **P**, **A**, and  modes, the zoom ratio increases by about 2×. When  (Microscope Control) is selected in  mode, you have a choice between 2× and 4× zoom.

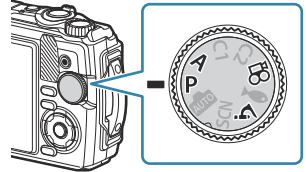

1. Rotate the mode dial to **P**, **A**, , or .

- If the mode dial is rotated to , select  (Microscope Control).





2. If the mode dial is rotated to **P**, **A**, or , press .

If the mode dial is rotated to , press .

- If the mode dial is rotated to **P**, **A**, or , the monitor display zoom is increased by 2×, and  is displayed. Images are recorded at the selected zoom ratio. Press  again to cancel zoom.



- If the mode dial is rotated to , pressing  increases zoom by 2×. Press  again for 4× zoom, and a third time to cancel zoom.

 JPEG images are recorded at the selected zoom ratio. In the case of RAW images, a frame shows the zoom crop. A frame showing the zoom crop is displayed on the image during playback.

 In the case of 4K and high-speed movies, the digital teleconverter is automatically disabled when recording starts.













 **[AF Area]** is fixed at **[[]]** (single target).



Sequential shooting/using the self-timer

Adjust settings for burst or self-timer photography. Choose an option according to your subject.







🔒 Secure the camera firmly on a tripod for self-timer shooting.

1. Press the  button.
2. Highlight an option using  or the control dial.

	Single	One frame is taken at a time when the shutter button is pressed.
	Sequential High	Hold the shutter-release button all the way down to take a series of photographs. <ul style="list-style-type: none">• To select a frame advance rate, highlight [Sequential High] and press the INFO button before you press the OK button. Select from frame advance rates of approximately 10 frames per second (10 fps) or 20 frames per second (20 fps). Use    or the control dial to highlight a frame advance rate and press the OK button to select. <p>🔒 Flash is disabled.</p>
	Sequential Low	Pictures will be taken at about 5 fps while the shutter button is pressed all the way down.
	Self-timer 12sec	Press the shutter button halfway to focus, then all the way down to start the timer. First, the self-timer lamp lights up for approximately 10 seconds, then it blinks for approximately 2 seconds, and then the picture is taken.
	Self-timer 2sec	Press the shutter button halfway to focus, then all the way down to start the timer. The self-timer lamp blinks for approximately 2 seconds, and then the picture is taken.
	Custom Self-timer	Press the INFO button to set [🕒 Timer] , [Number of Frames] , and [Interval Length] . Use  to highlight items and   to select a value. Focus, exposure, and white balance are fixed at the values for the first shot of each series.

Pro Cap	Pro Capture	<p>Sequential shooting begins when you press the shutter button halfway. Press the shutter button all the way down to begin recording captured images to the card, including those captured when the shutter button was pressed halfway. Focus, exposure, and white balance are locked at the values for the first shot of each series.  "Shooting without a release time lag (Pro Capture shooting)" (P.62)</p> <p> Flash is disabled.</p>
---------	-------------	---

3. Press the **OK** button.

-  During sequential shooting, if the battery level icon blinks due to low battery, the camera stops shooting and starts saving the pictures you have taken on the card. The camera may not save all of the pictures depending on how much battery power remains.
-  If you stand in front of the camera to press the shutter button when using the self-timer, the picture may be out of focus.
-  When you are using , live view is displayed. In  mode, the shot immediately preceding the current frame is displayed.
-  To cancel the activated self-timer, press the **MENU** button.
-  Self timer is not canceled automatically after shooting.

Shooting without a release time lag (Pro Capture shooting)

In Pro Capture mode, the camera records pictures at a rate of about 10 frames per second, starting approximately 0.5 seconds before the shutter button is pressed all the way down. Use this mode to capture moments you might otherwise miss due to shutter lag.

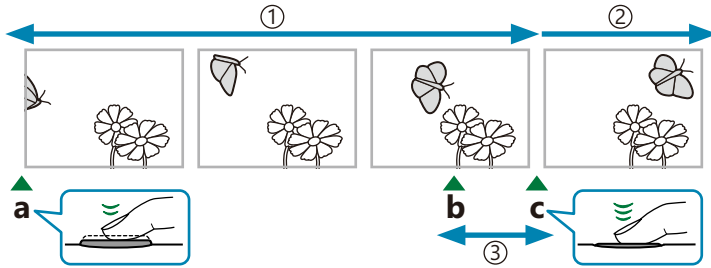

① Up to 5 frames

② Burst shooting continues

③ Shutter lag

a Shutter button pressed halfway

b Moment you want to capture

c Shutter button pressed all the way down

To eliminate the lag between the time the shutter button is pressed all the way down and the start of recording, the camera starts shooting a series of pictures using the electronic shutter when the shutter button is pressed halfway, and begins recording the pictures—including those taken when the shutter button was pressed halfway (up to 5)—to the card when the shutter button is pressed all the way down.

1. Press the  button (▼).

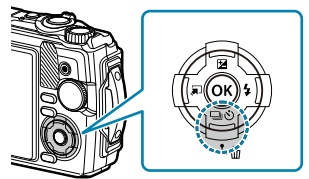

2. Highlight [**Pc**] (Pro Capture) using ◀▶ or the control dial and press the **OK** button.

3. Press the shutter button halfway to start capturing.

- The camera will continue shooting for up to a minute while the shutter button is pressed halfway. To resume shooting, press the button halfway again.

4. Press the shutter button all the way down to start saving pictures to the memory card.



- ⚠ Flickering caused by fluorescent lights, large movements by the subject, etc. may result in distortion in images.
- ⚠ When capturing, the display will not become dark, and no shutter sound will be made.
- ⚠ The slowest shutter speed is limited.





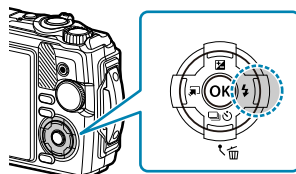







Using flash (flash photography)





You can use flash when shooting.

1. Press the  button ().



2. Highlight a flash mode using   or the control dial and press the **OK** button.

	Flash Auto	The flash fires automatically in dim or backlit conditions.
	Fill In	The flash fires regardless of lighting conditions.
	Red-eye	The flash fires to reduce the red-eye phenomenon.
	Flash Off	The flash does not fire.
	Slow Synchronization + Red-eye	Slow synchronization is combined with red-eye reduction flash.
	Slow Synchronization (1st Curtain)	The flash fires with slow shutter speeds to brighten dimly-lit backgrounds.
	Manual Value	Control flash output manually. If you highlight [Manual Value] and press the INFO button before pressing the OK button, you can adjust flash output using    or the control dial.
	Remote Control	The dedicated underwater flash or wireless RC flash is used to take pictures. For details, refer to “Taking pictures with the Wireless RC Flash System” (P.236) .
	LED On	The LED illuminator turns on when a picture is taken. This is effective for taking close up pictures.

- ⓘ When using [] (Red-eye), it takes about 1 second for the shutter to release following the initial pre-flashes. Do not move the camera until shooting is complete.
- ⓘ [] (Red-eye) may not work effectively under some shooting conditions.
- ⓘ The shutter speed becomes slower in [] (Slow Synchronization (1st Curtain)). Use a tripod to secure the camera in place.
- ⓘ Some features may be unavailable depending on the shooting mode and camera settings.  ["List of configurable shooting modes" \(P.206\)](#)

Focus lock

Lock the focus at the desired position.

1. Press the shutter button halfway to focus.
2. While keeping the shutter button pressed halfway, press the **OK** button.
 - The camera focuses and locks the position.

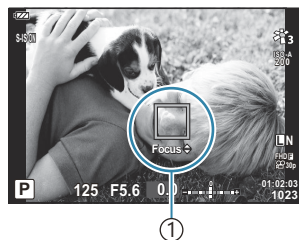

① AF lock indicator

- ⚙ While focus lock is in effect, the focus distance can be fine-tuned using Δ ∇ or the control dial.
- ⚙ Pressing the **OK** button, zooming in or out, pressing the **MENU** button, or performing other operations also releases the focus lock.
- ⚙ If the focus indicator blinks when the shutter button is pressed halfway with [**Live Composite**] (P.43, P.46) selected for **SCN** mode, you can set focus to infinity by pressing the **OK** button.
- ⚠ Focus lock is not available in **AUTO** mode and some **SCN** modes.

Using the LED illuminator

Unlike the flash, which lights up only briefly, the LED illuminator stays lit for longer periods. It can also serve as a flashlight.

Turning the LED illuminator on

1. Press and hold the **INFO** button.

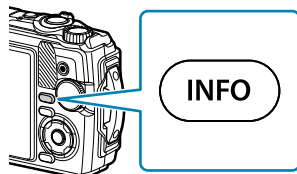

2. Release the button when the LED illuminator lights up.
 - The illuminator will light up even if the camera is off.

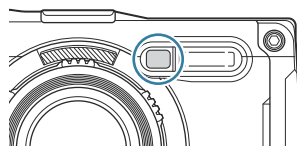

If the camera is on

The LED illuminator will remain lit for up to around 90 seconds while camera controls are in use, or up to 30 seconds if no operations are performed.

- The LED illuminator can be used during movie recording. It cannot, however, be used to film 4K movies.

If the camera is off

The LED illuminator will remain lit for up to around 30 seconds, whether or not you attempt to operate camera controls.

- The LED illuminator turns off automatically if you:
 - press the **ON/OFF** button,
 - use the LOG switch,
 - display the menu,
 - connect or disconnect a USB cable, or
 - connect to a Wi-Fi network.

To turn the LED illuminator off

Press and hold the **INFO** button down until the LED illuminator turns off.

Live Control

Settings accessible via Live Control

You can use Live Control to select the shooting function while checking the effect on the screen.

- The selected settings apply in **P**, **A**, and  modes.



- ① Functions
- ② Settings

Available settings

Picture Mode (P.71)

Scene mode ¹ (P.43)

ISO sensitivity (P.74)

White balance (P.75)

AF mode (P.78)

Aspect ratio (P.79)

 Image quality (P.80)

 Movie quality (P.82)

 Image stabilization settings ² (P.84)

 Image stabilization settings ³ (P.84)

Flash ^{2, 4} (P.64)

Flash intensity control ² (P.85)

Sequential/self-timer shooting (P.60)

Metering ² (P.86)



Face priority (P.87)

Accessory (P.88)

1 Displayed only in scene modes.

2 Not displayed in movie mode.

3 Displayed only in movie mode.

4 The camera stores the settings for **P** or **A**,  (underwater mode), and  (microscope mode) separately and restores them the next time the mode is selected, even after the camera has been turned off.

1. Press the **OK** button to display Live Control.

- To hide Live Control, press the **OK** button again.

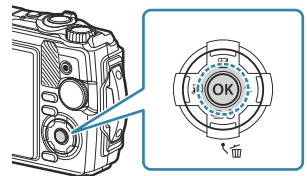

2. Use Δ ∇ to highlight the desired function and \triangleleft \triangleright to highlight a setting, and then press the **OK** button.
- You can also use the control dial to select a setting.
 - The selected settings take effect automatically if no operations are performed for about 8 seconds.

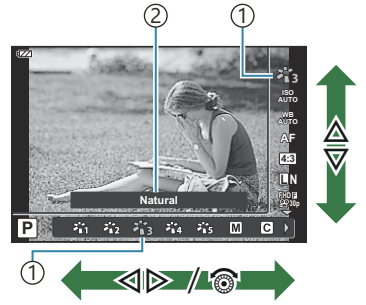

- ① Cursor
- ② Displays the selected function name

- Some functions are not available in some shooting modes. “List of configurable shooting modes” (P.206)

For the default settings of each option, refer to “Default Settings” (P.216).

Processing options (Picture Mode)

Select the color tone of the image. You can also make individual adjustments to contrast, sharpness, and other parameters (P.123). Changes to parameters are stored for each picture mode separately.

1. Press the **OK** button and then highlight Picture Mode using $\Delta \nabla$.

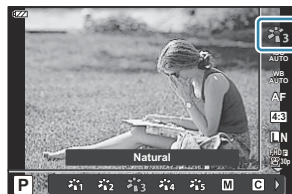

2. Highlight an option using $\triangleleft \triangleright$ and press the **OK** button.

Picture mode options

i-Enhance	Produces more impressive-looking results suited to the scene.
Vivid	Produces vivid colors.
Natural	Produces natural colors.
Muted	Produces flat tones.
Portrait	Produces beautiful skin tones.
Monochrome	Produces a black and white tone.
Custom	Select an existing picture mode, edit its parameters, and save it as a custom picture mode.
e-Portrait	Smooths out skin tones and texture. This mode cannot be used with bracket photography or when shooting movies.
Underwater	Process pictures to preserve the vivid colors seen under water. <ul style="list-style-type: none">• We recommend selecting [Off] for [$\frac{1}{2}$ +WB] (P.148) when [$\frac{1}{2}$ Underwater] is in effect.
Pop Art I/II	Enhances the color and atmosphere of an image to be brighter and vivid.

Soft Focus	Produces an ethereal atmosphere with soft tones, making the image appear dreamlike.
Pale&Light Color I/II	Produces the effect of subjects floating in gentle light by scattering light across the image and slightly overexposing it.
Light Tone	Produces a high-quality image by softening both shadows and highlights.
Grainy Film I/II	Produces the impact and roughness of a black and white photograph.
Pin Hole I/II/III	Produces a tunnel effect like that produced using an old-fashioned camera or a toy camera by reducing peripheral brightness.
Diorama I/II	Produces the effect of a surreal miniature world by enhancing the saturation and contrast and blurring the out-of-focus areas of the image.
Cross Process I/II	Produces an unsettled, surreal atmosphere.
Gentle Sepia	Produces a high-quality image with a calm atmosphere by drawing out shadows and softening the overall image.
Dramatic Tone I/II	Enhances the local contrast of an image, emphasizing the difference between bright areas and dark areas.
Key Line I/II	Produces the effect of an illustration by emphasizing edges.
Watercolor I/II	Produces a soft, bright image by removing dark areas, blending pale colors on a white canvas, and further softening contours.
Vintage I/II/III	Produces a slice-of-life effect in a nostalgic, vintage tones with the discoloration and fading seen in printed film.
Partial Color I/II/III	Makes the subject appear more impressive by extracting the colors you want to emphasize and keeping everything else monotone.
Bleach Bypass I/II	Often seen in movies and other productions, the “bleach bypass” effect is added to give greater impact to cityscapes and metal textures.
Instant Film	A contemporary take on the skin tones and shadow gradations typical of film.

II and III are altered versions of the original (I).

- When **[ART]** is selected for picture mode, **[Color Space]** will be fixed at **[sRGB]**.   Custom Menu **E** > **[Color Space]** (P.149)

Using [Partial Color]

Record only selected hues in color.

1. Press the **OK** button and then highlight Picture Mode using $\Delta \nabla$.
2. Highlight **[Partial Color I/II/III]** using $\triangleleft \triangleright$.
3. Press the **INFO** button.
 - A color ring appears in the display.
4. Select a color using $\triangleleft \triangleright$ or the control dial.
 - The effect is visible in the display.
5. Release the shutter.

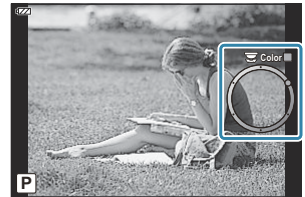

Changing ISO sensitivity (ISO Sensitivity)

Select a value according to subject brightness. Higher values enable you to photograph darker scenes but also increase image "noise" (mottling).

1. Press the **OK** button and then highlight ISO sensitivity using $\Delta \nabla$.



2. Highlight an option using $\triangleleft \triangleright$ and press the **OK** button.

AUTO	Sensitivity is adjusted automatically according to shooting conditions. The maximum ISO sensitivity value and other auto ISO settings can be adjusted using the [ISO-Auto Set] option in Custom Menu (P.147) .
100–12800	The sensitivity is set to the selected value.

Adjusting color (white balance)















White balance (WB) ensures that white objects in images recorded by the camera appear white. [WB AUTO] is suitable in most circumstances, but other values can be selected according to the light source when [WB AUTO] fails to produce the desired results or you wish to introduce a deliberate color cast into your images.





1. Press the **OK** button and then highlight White balance using $\Delta \nabla$.



2. Highlight an option using $\triangleleft \triangleright$ and press the **OK** button.

WB mode		Color temperature	Light conditions
WB AUTO	Auto white balance	—	Most normal scenes (scenes containing objects that are white or close to white). <ul style="list-style-type: none">• This mode is recommended in most situations.

WB mode		Color temperature	Light conditions
	Preset white balance	5300K	Sunlit outdoor scenes, sunsets, fireworks
		7500K	Daylight shots of subjects in the shade
		6000K	Shots taken in daylight under overcast skies
		3000K	Subjects under incandescent lighting
		4000K	Subjects under fluorescent lighting
		—	For pictures taken in shallow waters (approximately 3 m (9.8 ft.) or less)
		—	For pictures taken underwater at depths of from 3 to 15 m (9.8 to 49.2 ft.)
		—	For pictures taken underwater at below 15 m (49.2 ft.) <ul style="list-style-type: none"> • Use an underwater case at depths below 15 m (49.2 ft.).
		5500K	For flash shooting
		One-touch white balance	Color temperature set for One Touch WB
	Custom white balance	2000K–14000K	Situations in which you can identify the appropriate color temperature <ul style="list-style-type: none"> • After pressing the INFO button, use    to select a color temperature and then press the OK button.

 The water depths described for , , and  are only for guide. They may vary depending on weather and sea conditions.

One Touch WB

White balance is measured by framing a piece of paper or other white object under the lighting that will be used in the final photograph. This is useful when shooting a subject under natural light, as well as under various light sources with different color temperatures.

1. After selecting [**W1**], [**W2**], [**W3**], or [**W4**] (One Touch WB 1, 2, 3, or 4), press the **INFO** button.

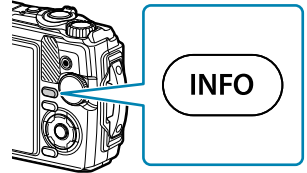

- The One Touch WB screen appears.
2. Photograph a piece of colorless (white or gray) paper.
 - Frame the piece of paper so that it fills the display. Ensure that it is free of shadows.
 3. Highlight [**Yes**] and press the **OK** button.
 - The new value is saved as a preset white balance option.
 - The new value is stored until One Touch WB is measured again. Turning the power off does not erase the data.

Selecting a focus mode (AF mode)



Select a focusing method (focus mode).

- Separate options can be selected for still photography and movie mode.





1. Press the **OK** button and then highlight AF mode using $\Delta \nabla$.



2. Highlight an option using $\triangleleft \triangleright$ and press the **OK** button.

AF	Auto Focus	The camera focuses automatically when the shutter button is pressed halfway. You can select the focus area in the shooting menu. <ul style="list-style-type: none">• The camera adjusts focus continuously during movie recording.
MF	Manual Focus	Use $\Delta \nabla$ or the control dial to focus manually on a subject anywhere in the frame. Manual focus can be enabled by pressing and holding the OK button during shooting.
	AF Super Macro	Focus at short distances using auto focus.
	MF Super Macro	Focus at short distances using manual focus.

 The camera may be unable to focus if the subject is poorly lit, obscured by mist or smoke, or lacks contrast.

  and  are available only in **P**, **A**, and  modes.

Setting the aspect ratio

Choose the ratio of width to height for pictures according to your intent, what you want to achieve when printing the photo, and so on. In addition to the standard aspect (width-to-height) ratio of **[4:3]**, the camera offers settings of **[16:9]**, **[3:2]**, **[1:1]**, and **[3:4]**.

1. Press the **OK** button and then highlight Aspect ratio using $\Delta \nabla$.



2. Highlight an option using $\triangleleft \triangleright$ and press the **OK** button.

- 🔗 Aspect ratio can only be set for still images.
- 🔗 JPEG images cropped to the selected aspect ratio are saved. RAW images are not cropped and are saved with the selected aspect ratio information.
- 🔗 When RAW images are played back, the selected aspect ratio is indicated by a frame.

Photo file and image size options (📷 Image quality)

You can select an image quality mode for still images. Select a quality suitable for the application (such as for processing on PC, using on a website, etc.).







1. Press the **OK** button and then highlight 📷 Image quality using Δ ∇ .



2. Highlight an option using  and press the **OK** button.

- You have a choice of JPEG (**L**SF, **L**F, **L**N, and **M1**N) and RAW modes. When JPEG+RAW is selected, images in both JPEG and RAW format will be recorded at the same time. JPEG is made up of a combination of image size (**L**/**M1**/**M2**/**S**) and compression ratio (SF/F/N).

Option	Pixel count	Compression ratio	File format
L SF	4000×3000	SuperFine (1/2.7)	JPG
L F	4000×3000	Fine (1/4)	JPG
L N	4000×3000	Normal (1/8)	JPG
M1 N	3200×2400	Normal (1/8)	JPG
RAW	4000×3000	Lossless compression	ORF
RAW+JPEG	RAW plus the JPEG option selected above		

- ⓘ Pictures taken with an image quality setting of RAW are automatically recorded as JPEG+RAW in the following modes:
 - [ **Underwater HDR**], [ **Focus stacking**], [ **e-Portrait**], [ **Handheld starlight**], [ **Backlight HDR**]
- ⓘ The individual JPEG and RAW files recorded when taking photos while JPEG+RAW is selected cannot be deleted separately. Deleting one automatically deletes the other. (If you delete the JPEG copy on a computer and then copy the RAW image back to the camera, you will be able to edit the image (P.102) but you will not be able to select it for printing (P.113).)
- ⓘ The image size/compression combination can be changed in the menu.  **Custom Menu E** > [ **Set**] (P.149)

 RAW images are unprocessed image data to which settings such as exposure compensation and white balance have yet to be applied. They serve as raw data for images that will be processed after shooting.

- RAW image files: Have the extension “.orf”
- Cannot be viewed on other cameras.
- Can be viewed using OM Workspace digital photo management and editing software
- Can be saved in JPEG format using the camera’s **[RAW Data Edit]** (P.102) retouch option

Frame size, rate, and compression (🎥 Movie Quality)

You can set a movie quality suitable for the desired use.

1. Press the **OK** button and then highlight 🎥 Movie quality using $\Delta \nabla$.



2. Highlight an option using $\leftarrow \rightarrow$ and press the **OK** button.
 - “Movie quality” is a combination of frame size, bit rate (compression ratio), and frame rate.

Available movie quality options

The options available for movie quality vary with the options selected for **[Video Frame Rate]** and **[Video Bit Rate]** in the video menu (P.134).

- When shooting movies that will be viewed on a television, select a frame rate that matches the video standard used in the device, as the movie may not play back smoothly otherwise. Video standards vary by country or region: some use NTSC, others PAL.
 - When shooting for display on NTSC devices, select 60p (30p)
 - When shooting for display on PAL devices, select 50p (25p)
- Movies are stored in MPEG-4 AVC/H.264 format. The maximum size of individual file is limited to 4 GB. The maximum recording time of a single movie is limited to 29 minutes.
- Depending on the card used, recording may end before the maximum length is reached.
- The picture modes available vary with the option selected for the movie quality.
- Use UHS-I cards with a UHS Speed Class of 3 when filming 4K or high-speed movies.
- Use a card with a Speed Class of 10 or higher when filming FHD/HD movies.
- 4K movies may not play on some computer systems. More information is available on our website.

Record mode: 4K

Record 4K movies.

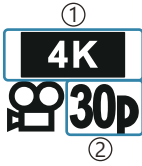

- ① Image size
4K: 3840×2160
- ② Frame rate
30p
25p

Record mode: FHD/HD

Record standard movies.



- ① Image size
FHD: 1920×1080
HD: 1280×720
- ② Bit rate (compression)
SF (Super Fine)
F (Fine)
N (Normal)
- ③ Frame rate
60P (30p)
50P (25p)

Record mode: HS (High-speed)

Record slow-motion movies. Footage shot at a high frame rate plays back at approximately 30 fps.



- ① Image size
- ② Frame rate
FHD: 1920×1080 120fps
HD: 1280×720 240fps
SD: 640×360 480fps

🔊 Recording can continue for up to 20 seconds.

🔍 Focus and exposure are fixed at the start of recording.

🔊 Sound is not recorded.

🚫 This mode is not available in **AUTO** or **SCN** mode.

Reducing camera shake (Image stabilizer)

You can reduce the amount of camera shake that can occur when shooting in low light conditions or shooting with high magnification.

The image stabilizer starts when you press the shutter button halfway.

1. Press the **OK** button and then highlight Image stabilizer using $\Delta \nabla$.

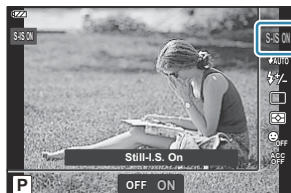

2. Highlight an option using $\triangleleft \triangleright$ and press the **OK** button.

Still pictures

S-IS Off	Image stabilizer is off.
S-IS On	Optimal image stabilizer enabled.

Movie

M-IS Off	Image stabilizer is off.
M-IS On	Image stabilizer enabled.



 The edges of the frame are cropped out when **[M-IS On]** is selected, reducing the area recorded.

 Image stabilizer is set to **[M-IS Off]** when **[FHD HS 120fps]**, **[HD HS 240fps]**, or **[SD HS 480fps]** are selected for movie quality.

 When using a tripod, set Image stabilizer to **[S-IS Off]** or **[M-IS Off]**.

 Image stabilizer may be unable to fully compensate for the effects of camera movement if the movement is very large or the shutter speed very slow. In these cases, it is recommended that you use a tripod.

 You may notice an operating sound or vibrations when the image stabilizer is activated.

Adjusting flash output (Flash intensity control)

Flash output can be adjusted if you find that your subject appears overexposed, or that it appears underexposed even though the exposure in the rest of the frame is just right.

1. Press the **OK** button, then highlight Image stabilizer using $\Delta \nabla$.



2. Highlight an option using $\triangleleft \triangleright$ and press the **OK** button.
 - Flash brightness can be reduced by selecting negative values (the lower the value, the dimmer the flash) or increased by selecting positive values (the higher the value, the brighter the flash).

ⓘ Not available in **Auto** mode, when [Underwater HDR] is selected in **Underwater** mode, or in **SCN** mode.



Choosing how the camera measures brightness (Metering)

You can select how the camera meters subject brightness.

1. Press the **OK** button and then highlight Metering using $\Delta \nabla$.



2. Highlight an option using $\triangleleft \triangleright$ and press the **OK** button.

	ESP	Balances brightness across the screen when shooting (The brightness at the center and surrounding areas of the screen are measured separately). When [ESP] is selected, the center may appear dark when shooting against strong backlighting.
	Spot	Shoots the subject at the center in backlit conditions (The brightness is measured at the center of the screen).

Automatic face detection (Face priority)

The camera detects faces and adjusts focus and digital ESP.

1. Press the **OK** button and then highlight Face priority using $\Delta \nabla$.

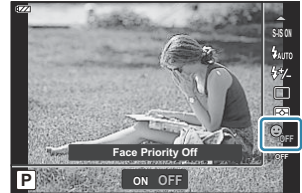

2. Highlight an option using $\triangleleft \triangleright$ and press the **OK** button.

ON	Face Priority On	The camera detects and focuses on faces.
OFF	Face Priority Off	Face priority is off.





Using optional accessories (Accessory)

Use this option when optional accessories are attached.

1. Press the **OK** button and then highlight Accessory using $\Delta \nabla$.



2. Highlight an option using $\triangleleft \triangleright$ and press the **OK** button.

OFF	Accessory Off	Take pictures using the camera alone.
	PTWC-01	Select according to the optional accessory attached.
	TCON-T01	
	FCON-T01	
	FCON-T02	
FD-1	FD-1	

 ["Optional accessories" \(P.237\)](#)

Playback

Information display during playback

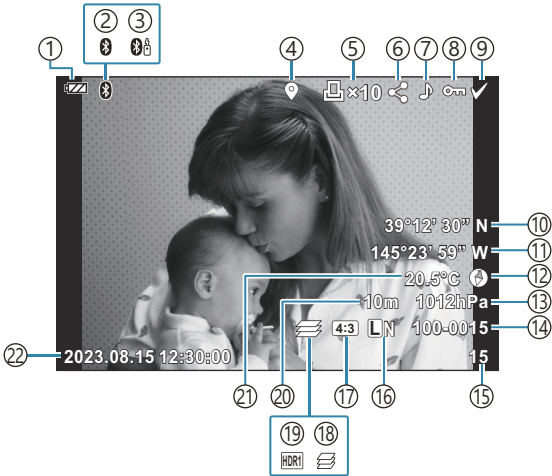

Playback image information

Simplified display

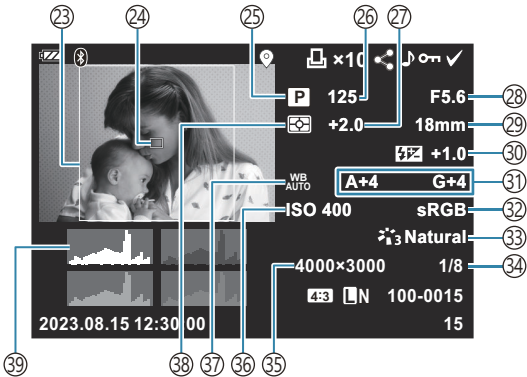

Overall display



- ① Battery level (P.27)
- ② Active **Bluetooth**[®] connection (P.174)
- ③ Remote control (P.186)
- ④ Including GPS information (P.202)
- ⑤ Print order
 - Number of prints (P.113)
- ⑥ Share Order (P.107)
- ⑦ Record Sound (P.109)
- ⑧ Protect (P.108)
- ⑨ Sel. Image (P.97)
- ⑩ Latitude (P.205)
- ⑪ Longitude (P.205)
- ⑫ Direction information (P.205)
- ⑬ Atmospheric (P.205)
- ⑭ File number
 -   Custom Menu  > [File Name] (P.151)
- ⑮ Frame number
- ⑯ Image quality (P.80, P.82)
- ⑰ Aspect ratio (P.79)
- ⑱ Focus stacking (P.49)
- ⑲ HDR image (P.43, P.51)
- ⑳ Altitude/water depth (P.205)
- ㉑ Temperature (water temperature) (P.205)
- ㉒ Date and time (P.28)
- ㉓ Aspect border ¹ (P.79)
- ㉔ AF target display (P.125)
- ㉕ Shooting mode (P.35)
- ㉖ Shutter speed (P.39, P.41)
- ㉗ Exposure compensation (P.58)
- ㉘ Aperture value (P.39, P.41)
- ㉙ Focal length
- ㉚ Flash intensity control (P.85)
- ㉛ White balance compensation (P.149)
- ㉜ Color Space (P.149)
- ㉝ Picture Mode (P.71)
- ㉞ Compression rate (P.80, P.161)
- ㉟ Pixel count (P.80, P.161)
- ㊱ ISO sensitivity (P.74)
- ㊲ White balance (P.75)
- ㊳ Metering mode (P.86)
- ㊴ Histogram

1 Displayed only if an aspect ratio other than 4:3 is selected with a RAW image quality option.

Switching the information display

You can switch the information displayed during playback by pressing the **INFO** button.

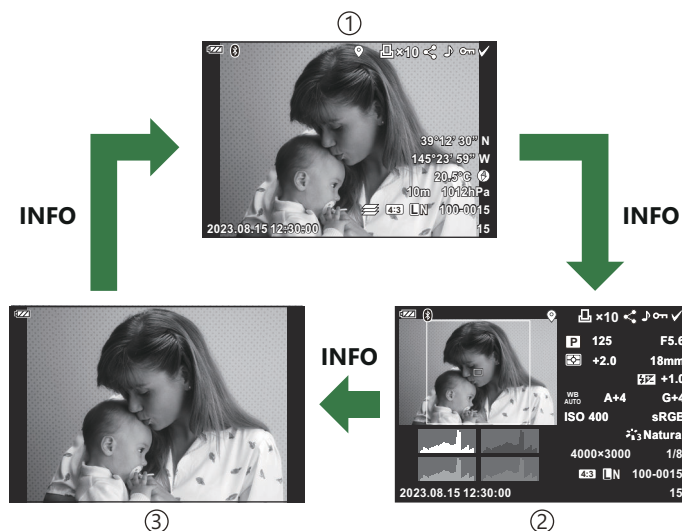
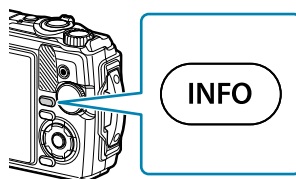



- ① Simplified display
- ② Overall display
- ③ Image only

🔊 You can add histogram and highlight-and-shadow displays to the information shown during playback. 🖱️ **Custom Menu B** > [**Info Settings**] > [**Info**] (P.156)

Viewing photographs and movies













Viewing still pictures



1. Press the  button.

- The last photograph you shot will be displayed.
- Select the desired photograph or movie using the control dial or arrow pad.
- To return to shooting mode, press the shutter button halfway or press the  button.



Still pictures

Control dial	<ul style="list-style-type: none">• Single-frame playback: Previous () / Next ()• Close-up playback: You can display the next frame or the previous frame during close-up playback (P.95).• Index/calendar playback: Highlight image (P.94)
Arrow pad (   )	<ul style="list-style-type: none">• Single-frame playback: display the next frame () / display the previous frame ()• Close-up playback: Changing the close-up position (P.95) You can display the next frame () or the previous frame () during close-up playback by pressing the INFO button.• Index/calendar playback: Highlight image (P.94)
Zoom lever	Rotate the zoom lever counterclockwise for index or calendar playback (P.94). Rotate the zoom lever clockwise for close-up playback (P.95).
INFO button	View image info (P.91)
 button ()	Delete picture (P.98)

<p>OK button</p>	<p>Display the menu (or exit to single-frame playback from close-up playback or calendar playback).  "Using functions during playback" (P.99)</p>
<p>☉ button (☑)</p>	<p>You can select multiple images for [☉], [Erase Selected] or [Share Order Selected].  "Selecting multiple pictures (Share Order Selected, ☉, Erase Selected)" (P.97)</p>

Viewing movies









1. Press the  button.
 - The last photograph you shot will be displayed.



Movie

2. Press the **OK** button.
 - The playback direct menu will be displayed.



3. Highlight [**Play Movie**] and press the **OK** button.
 - Movie playback will start.
 - Fast forward and rewind using  / .
 - Press the **OK** button to pause playback. While the movie is paused, press  to display the first frame and  to display the last frame. Move to previous or next frames using   or the control dial.
 - To end playback, press the **MENU** button.
 - Use   to adjust the volume during playback.



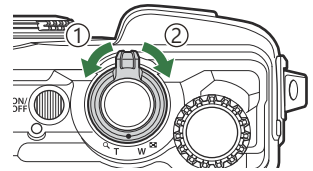

Finding pictures quickly (Index and Calendar Playback)

Rotating the zoom lever counterclockwise (toward ) during single-frame playback initiates index playback. Rotate to the end for calendar playback.





① Counterclockwise ( side)

② Clockwise ( side)



- Use     or the control dial to move the cursor.
- Rotate the zoom lever clockwise () to proceed in turn from calendar to index to single-frame playback.
- To exit from calendar to single-frame playback, press the **OK** button.



- ① Single-frame playback
- ② Index display
- ③ Calendar display

 You can change the number of frames for index display.  [\[Settings\] \(P.158\)](#)



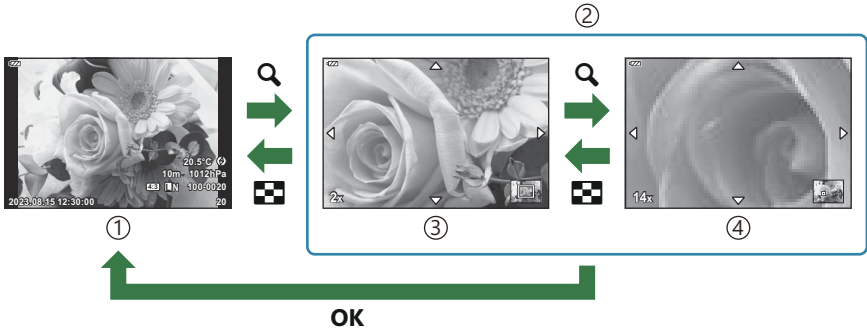
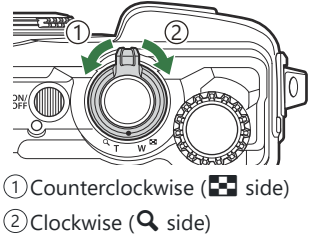

Zooming in (Close-up Playback)

To use zoom on the current picture during single-frame playback, rotate the zoom lever clockwise (toward ) to zoom in and counterclockwise (toward ) to zoom out. Press the **OK** button to return to single-frame playback.



- ① Single-frame playback
- ② Close-up playback

- ③ 2x zoom
- ④ 14x zoom

- Press    to scroll through an image in the direction of the button you pressed.
- To view other images while zoomed in, press the **INFO** button and then press . Press the **INFO** button again to re-enable scrolling. You can also view other images using the control dial.

Scrolling playback of panoramas

Perform scrolling playback of a series of images that are combined to create a panorama.

1. Select a panorama using single-frame playback.
2. Rotate the zoom lever clockwise (toward **Q**).

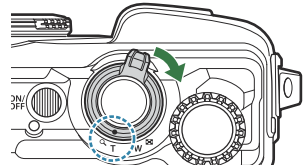

- Press **Δ ▽ <|>** to scroll through an image in the direction of the button you pressed.





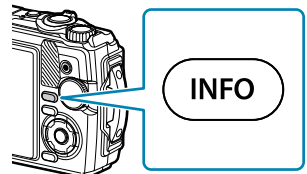

① Area currently playing back

- To use zoom on the current picture during scrolling playback of a panorama, rotate the zoom lever clockwise for zoom in (ratios of 2× to 14×), and counterclockwise to zoom out. Press the **OK** button to return to single-frame playback.
- To view other images while zoomed in at a ratio of 2× or higher, press the **INFO** button, then press **<|>**. Press the **INFO** button again to re-enable scrolling. You can also view other images using the control dial.



Selecting multiple pictures (Share Order Selected, , Erase Selected)

You can select multiple images for **[Share Order Selected]**, **[]**, or **[Erase Selected]**.

1. Select pictures by pressing the  () button during playback.
 - The image will be selected and  will be displayed.
To cancel selection, press the button again.
 - You can select an image during single-frame playback and index playback.
2. Press the **OK** button to display the menus and choose **[Share Order Selected]**, **[]**, or **[Erase Selected]**.

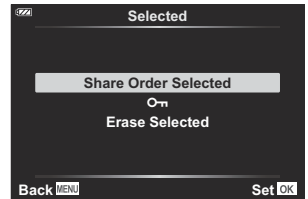

Deleting pictures (Erase)

1. Display an image you want to delete and press the  (▽) button.

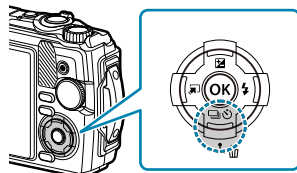

2. Highlight **[Yes]** and press the **OK** button.





- The image will be deleted.

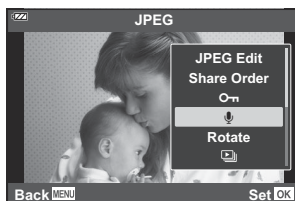
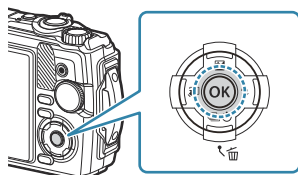

Using functions during playback



The playback direct menu can be displayed by pressing the **OK** button during playback. Highlight the desired option and select it by pressing the **OK** button.



- Play  (P.101)
- Raw Data Edit (P.102)
- JPEG Edit (P.103)
- Play Movie (P.93)
- Movie Edit (P.105)
- Share Order (P.107)
-  (P.108)
-  (P.109)
- Rotate (P.110)
-  (P.111)
- Image Overlay (P.112)
-  (P.113)
- Erase (P.116)

The options displayed vary with the type of image selected.

	RAW	JPEG	RAW+JPEG	Movie
Play 	○	○	○	×
RAW Data Edit	○	×	○	×
JPEG Edit	×	○	○	×
Play Movie	×	×	×	○
Movie Edit	×	×	×	○
Share Order	○	○	○	○
	○	○	○	○
	○	○	○	×
Rotate	○	○	○	×

	RAW	JPEG	RAW+JPEG	Movie
	○	○	○	○
Image Overlay	○	×	○	×
	×	○	○	×
Erase	○	○	○	○

Playing back voice memos (Play 🎵) when the associated image is displayed

Voice memos ([P.109](#), [P.133](#)) are played back when the associated image is displayed.

1. Select a photo with audio and press the **OK** button.
 2. Highlight [**Play** 🎵] and press the **OK** button.
 - Audio playback will start.
- To end audio playback, press the **OK** or **MENU** button.
 - Use **△ ▽** to adjust volume during playback.

Retouching pictures (RAW Data Edit/JPEG Edit)

Create retouched copies of pictures. In the case of RAW pictures, you can adjust the settings in effect at the time the picture was taken, such as white balance and picture mode (art filters included). With JPEG pictures, you can make simple edits such as cropping and resizing.

RAW Data Edit	Retouch pictures and save the resulting copies in JPEG format (P.102). The following options are available: [Current] : Save the picture using the settings currently selected on the camera. [ART BKT] : The camera creates multiple JPEG copies of each image, one for each art filter selected. Select one or more filters and apply them to one or more images.
JPEG Edit	Retouch JPEG pictures and save the resulting copies in JPEG format (P.103).

Retouching RAW Pictures (RAW Data Edit)

1. During playback, display the photo you want to retouch and press the **OK** button.
2. Highlight **[RAW Data Edit]** and press the **OK** button.
 - Edit options will be displayed.

ⓘ If the current picture is not a RAW image, **[RAW Data Edit]** will not be displayed. Select a different image.
3. Highlight items using the Δ ∇ buttons.
 - To apply current camera settings, highlight **[Current]** and press the **OK** button. The current settings will be applied.
 - Highlight **[Yes]** using Δ ∇ and press the **OK** button to create a JPEG copy using the selected settings.
 - Highlighting **[ART BKT]** and pressing \triangleright displays a list of art filters. Highlight art filters and press the **OK** button to select or deselect. Selected filters are marked with a \checkmark . Press the **MENU** button to return to the previous display once all the desired filters have been selected.
 - Press the **OK** button to record the image after processing with the selected art filter.



4. To create additional copies from the same original, highlight **[Reset]** and press the **OK** button. To exit without creating more copies, highlight **[No]** and press the **OK** button.
- Selecting **[Reset]** displays editing options. Repeat the process from Step 3.

ⓘ RAW pictures cannot be retouched if:

- there is not enough space on the memory card or if the picture was created with a different camera.

Retouching JPEG Pictures (JPEG Edit)

The **[JPEG Edit]** menu contains the options listed below.

Shadow Adj	Brighten back-lit subjects.
Red-eye Fix	Reduce "red-eye" in pictures taken with flash.
	Crop pictures. Adjust the crop size with the control dial and position it with $\Delta \nabla \triangleleft \triangleright$.
Aspect	Change the aspect ratio from the standard 4:3 to [3:2] , [16:9] , [1:1] , or [3:4] . After choosing an aspect ratio, use $\Delta \nabla \triangleleft \triangleright$ to position the crop.
Black & White	Create a black-and-white copy of the current picture.
Sepia	Create a sepia copy of the current picture.
Saturation	Adjust the vividness of colors. The results can be previewed in the display.
	Create a copy resized to 1280 × 960, 640 × 480, or 320 × 240 pixels. Pictures with an aspect ratio other than the standard 4:3 are resized to dimensions as close as possible to the selected option.
e-Portrait	Produce smooth complexions. The desired effect may not be achieved if no faces are detected.

ⓘ Red-eye correction may not work depending on the image.

ⓘ Editing of a JPEG image is not possible in the following cases:

- When an image is processed on a PC, when there is not enough space in the card memory, or when an image is recorded on another camera

ⓘ  cannot be used to make pictures larger.

① [] cannot be applied to some.

① [] (crop) and **[Aspect]** only apply to pictures with an aspect ratio of 4:3 (standard).

1. During playback, display the photo you want to retouch and press the **OK** button.

2. Highlight **[JPEG Edit]** and press the **OK** button.

- Edit options will be displayed.

① If the current picture is not a JPEG image, **[JPEG Edit]** will not be available. Select a different image.

3. Highlight an option using $\Delta \nabla$ and press the **OK** button.

- The effect can be previewed in the display. If multiple options are listed for the selected item, use $\Delta \nabla$ to choose the desired option.
- When [] is selected, you can adjust the crop size using the control dial and position it using $\Delta \nabla \triangleleft \triangleright$.
- When **[Aspect]** is selected, you can position the crop using $\Delta \nabla \triangleleft \triangleright$.

4. Highlight **[Yes]** and press the **OK** button.

- The edited image is stored in the card.

Editing movies (Movie Edit)

Edit movies.

Creating movie stills (In-Movie Image Capture)

Save a still copy (aspect ratio **[16:9]**) of a frame selected from a 4K movie recorded with the camera.

1. During playback, display the movie you want to edit and press the **OK** button.
2. Highlight **[Movie Edit]** and press the **OK** button.
3. Use $\triangle \nabla$ to highlight **[In-Movie Image Capture]** and press the **OK** button.
4. Use $\triangleleft \triangleright$ to select a frame to be saved as a still image and press the **OK** button.
 - Use $\triangle \nabla$ to skip multiple frames.
 - Press the **MENU** button to return to single-frame playback.

ⓘ The date of recording of the still may differ from that of the original movie.

Trimming movies (Movie Trimming)

Trim selected footage from movies recorded with the camera and either overwrite the original with the edited footage or save the edited copy separately.

1. During playback, display the movie you want to edit and press the **OK** button.
2. Highlight **[Movie Edit]** and press the **OK** button.
3. Use $\triangle \nabla$ to highlight **[Movie Trimming]** and press the **OK** button.
4. Highlight **[Overwrite]** or **[New File]** and press the **OK** button.
 - If the image is protected, you cannot select **[Overwrite]**.

5. Use <|> to highlight the desired option for whether the section to be deleted begins with the first frame or the last frame, then press the **OK** button.
 - To jump to the first or last frame, rotate the control dial.

6. Use <|> to select the section to be deleted.
 - The section to be deleted is shown in red.

7. Press the **OK** button.

8. Highlight **[Yes]** and press the **OK** button.

ⓘ The date of recording of the still may differ from that of the original movie.

Selecting pictures for sharing (Share Order)

You can select images you want to transfer to a smartphone in advance.

1. Display an image you want to transfer and press the **OK** button.
 - The playback menu will be displayed.
2. Select **[Share Order]** and press the **OK** button. Then, press Δ or ∇ .
 - The image is marked for sharing. A  icon and the file type will be displayed.
 - Up to 200 pictures can be marked for sharing at a time.
 - To cancel a share order, press Δ or ∇ .

 Share orders cannot include RAW images.

 You can select images you want to transfer in advance and set a share order all at once.

 ["Selecting multiple pictures \(Share Order Selected, !\[\]\(58518edde73d42d67a35a8ed26134c7b_img.jpg\), Erase Selected\)" \(P.97\)](#), ["Transferring images to a smartphone" \(P.177\)](#)

Protecting Pictures (🔒)

Protect images from accidental deletion.

1. Display an image you want to protect and press the **OK** button.

2. Select [🔒] and press the **OK** button. Then, press Δ or ∇ .

- Protected images are indicated by a 🔒 (“protected”) icon.



- Press Δ or ∇ to remove protection.

👉 You can also protect multiple selected images. 👉 [“Selecting multiple pictures \(Share Order Selected, 🔒, Erase Selected\)” \(P.97\)](#)

⚠️ Formatting the card erases all data including protected images.

Adding audio to pictures (🎤)

You can record audio using the built-in stereo microphone and add it to pictures. The recorded audio provides a simple replacement for written notes about the pictures. Audio recordings can be up to 30 s long.

1. Display the image to which you want to add audio and press the **OK** button.
 - Audio recording is not available with protected images.

2. Select [🎤] and press the **OK** button.

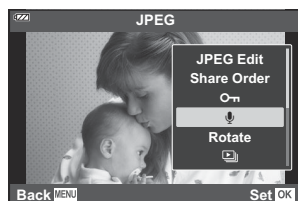

- To exit without adding audio, select **[No]**.

3. Select [🎤 **Start**] and press the **OK** button to begin recording.

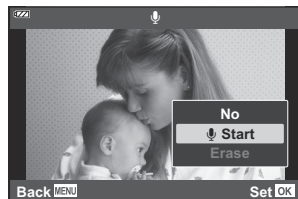

4. Press the **OK** button to end recording.
 - Pictures with audio are indicated by 🎵 icons.
 - To delete recorded audio, select **[Erase]** in Step 3.

🔗 Audio can also be added to pictures using the **[Edit]** option in the 📺 playback menu (P.135). Use **[Edit]** > **[Sel.Image]** to select the picture, then press the **OK** button and select [🎤].

🔗 The recorded audio can be played back using **[Play 🎵]** (P.101).

Rotating pictures (Rotate)

Choose whether to rotate photographs.

1. Display an image you want to rotate and press the **OK** button.
2. Select **[Rotate]** and press the **OK** button.
3. Press Δ to rotate the image counterclockwise and ∇ to rotate it clockwise. The image rotates each time the button is pressed.
 - Press the **OK** button to save changes and exit.
 - The rotated image is saved in its current orientation.
 - Movies and protected images cannot be rotated.

 The camera can be configured to automatically rotate portrait-orientation pictures during playback.

  [Playback Menu > \[\] \(P.136\)](#)

 **[Rotate]** is not available when **[Off]** is selected for [].

Playback images automatically ()

This function displays images stored on the card one after another.

1. Press the **OK** button in the playback display.
2. Highlight [] and press the **OK** button.

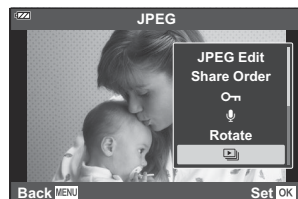

3. Configure the slideshow.

Start	Start the slideshow. Images are displayed in order, starting with the current image.
BGM	Turn the background music [On] or [Off] .
Slide	Set the type of data to be played back.
Slide Interval	Select the length of time each slide is displayed from 2 to 10 seconds.
Movie Interval	Select [Full] to play back full length of each movie clip in the slideshow or [Short] to play back only the opening portion of each movie clip.

4. Highlight **[Start]** and press the **OK** button.
 - The slideshow will start.
 - Press $\Delta \nabla$ during the slideshow to adjust the overall volume of the camera speaker. Press $\triangleleft \triangleright$ while the volume adjustment indicator is displayed to adjust the balance between the sound recorded with the image or movie and background music.
 - Press the **OK** button to stop the slideshow.

Combining pictures (Image Overlay)

Overlay existing RAW photos to create a new picture. Up to 3 pictures can be included in the overlay. The results can be modified by adjusting brightness (gain) separately for each picture.

1. Play the photograph back and press the **OK** button.
2. Select **[Image Overlay]** and press the **OK** button.
3. Select the number of images to be overlaid and press the **OK** button.
4. Highlight RAW images for the overlay using Δ ∇ \triangleleft \triangleright and press the **OK** button.

- A \checkmark icon will appear on the selected images. Press the **OK** button again to remove the \checkmark icon.

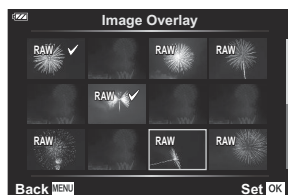

- An overlay will be displayed once the number of images selected in Step 3 have been selected.

5. Adjust the gain for each of the images in the overlay.

- Highlight images using the \triangleleft \triangleright buttons and adjust gain using the Δ ∇ buttons.
- Gain can be adjusted in the range 0.1 – 2.0. Check the results in the monitor.

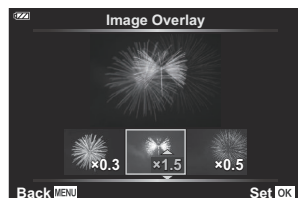

6. Press the **OK** button. A confirmation dialog will be displayed.

- Highlight **[Yes]** and press the **OK** button.

⚙ The image is saved with the image quality set at the time the image is saved (if **[RAW]** was selected for image quality, it will be saved as **[L F+RAW]**).

⚙ Overlays saved in RAW format can in turn be combined with other RAW images to create overlays containing 4 or more pictures.

Print order (DPOF)

You can save on the memory card digital “print orders” that list the pictures to be printed and the number of copies of each print. You can then have the pictures printed at a print shop that supports DPOF. A memory card is required when creating a print order.

Creating a print order

1. Press the **OK** button during playback and select [] (Print Order).
2. Select [] or [ALL] and press the **OK** button.

Individual pictures

Press <> to select a frame you want to add to the print order and then press Δ ∇ to choose the number of prints.

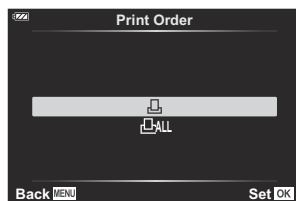

- Repeat this step as desired to add more pictures to the print order. Press the **OK** button when all the desired pictures have been selected.

All pictures

Select [ALL] and press the **OK** button.

3. Select the date and time format and press the **OK** button.

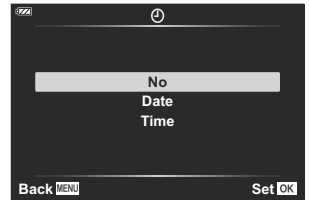

No	The pictures are printed without the date and time.
Date	The pictures are printed with the shooting date.
Time	The pictures are printed with the shooting time.

ⓘ When printing images, the setting cannot be changed between images.

4. Select **[Set]** and press the **OK** button.

- The setting will be applied to the images saved on the card being used for playback.

ⓘ The camera cannot be used to modify print orders created with other devices. Creating a new print order deletes any existing print orders created with other devices.

ⓘ Print orders cannot include RAW images or movies.

Removing all or selected pictures from the print order

You can reset all print order data or just the data for selected pictures.

1. Press the **OK** button during playback and select **[□]** (Print Order).

2. Select **[□]** and press the **OK** button.

- To remove all pictures from the print order, select **[Reset]** and press the **OK** button. To exit without removing all pictures, select **[Keep]** and press the **OK** button.
- You can also remove all pictures from the print order by selecting **[□ALL]** and choosing **[Reset]**.

3. Press <|> to select images you wish to remove from the print order.
 - Use ▾ to set the number of prints to 0. Press the **OK** button once you have removed all the desired pictures from the print order.

4. Select the date and time format and press the **OK** button.
 - This setting is applied to all images with print order data.
 - The setting will be applied to the images saved on the card being used for playback.

5. Select **[Set]** and press the **OK** button.

Deleting pictures (Erase)













Delete the current image.

- 1.** Play back the photograph you want to delete and press the **OK** button.
- 2.** Highlight **[Erase]** and press the **OK** button.
- 3.** Highlight **[Yes]** and press the **OK** button.
 - The image will be deleted.

Menu Functions



Basic menu operations

Menus can be used to customize the camera for ease of use and include shooting and playback options not displayed in the Live Control screen or elsewhere.

Tab	Tab name	Description
	Shooting Menu 1	Photography options. Ready the camera for shooting or access basic photo settings.  "Shooting Menus 1 and 2" (P.120)
	Shooting Menu 2	Photography options. Adjust advanced photo settings.  "Shooting Menus 1 and 2" (P.120)
	Video Menu	Movie recording options. Adjust basic and custom settings.  "The Video Menu" (P.134)
	Playback Menu	Playback and retouch options.  "The Playback Menu" (P.135)
	Custom Menu	Camera customization options.  "The Custom Menus" (P.144)
	Setup Menu	Options for setting the clock, choosing a language, and more.  "The Setup Menu" (P.139)

Functions that cannot be selected from menus

Some items may not be selectable from the menus when using the arrow pad.

- Items that cannot be set with the current shooting mode.  ["List of configurable shooting modes" \(P.206\)](#)
- Items that cannot be set because of an item that has already been set:
 - Settings such as picture mode are unavailable when the mode dial is rotated to .

1. Press the **MENU** button to view the menus.

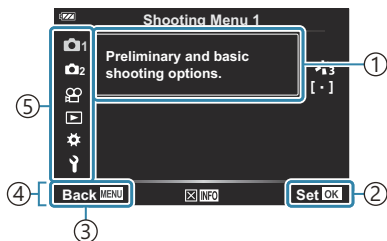

- ① Guide
- ② Press the **OK** button to confirm the setting
- ③ Press the **MENU** button to go back one screen
- ④ Operation guide
- ⑤ Tab

- A guide is displayed about 2 seconds after you select an option. Press the **INFO** button to view or hide guides.

2. Highlight a tab using the Δ ∇ buttons and press the **OK** button.

- Menu group tabs appear when Custom Menu is selected. Use Δ ∇ to select the menu group and press the **OK** button.

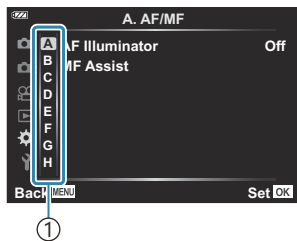

- ① Menu groups

3. Select an item using Δ ∇ and press the **OK** button to display options for the selected item.

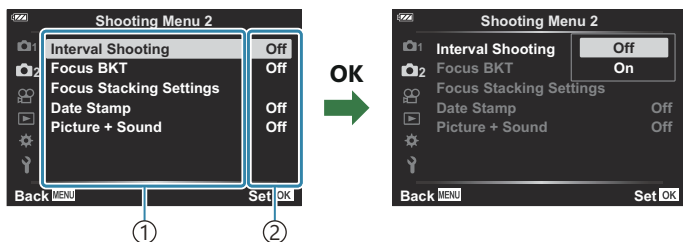

- ① Function
- ② The current setting is displayed

4. Use Δ ∇ to highlight an option and press the **OK** button to select.

- Press the **MENU** button repeatedly to exit the menu.

ⓘ Depending on camera status and settings, some items may be unavailable. Items that are not available are grayed out and cannot be selected.

🔗 For the default settings of each option, refer to [“Default Settings” \(P.216\)](#).

🔗 You can also navigate the menus using the front and rear dials in place of the arrow pad.

Using Shooting Menu 1/Shooting Menu 2

Shooting Menus 1 and 2

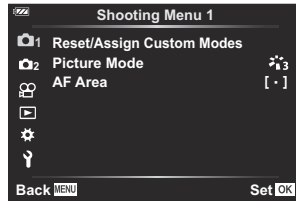

1 Shooting Menu 1

- Reset/Assign Custom Modes ([P.52](#), [P.121](#))
- Picture Mode ([P.71](#), [P.123](#))
- AF Area ([P.125](#))

2 Shooting Menu 2

- Interval Shooting ([P.127](#))
- Focus BKT ([P.130](#))
- Focus Stacking Settings ([P.131](#))
- Date stamps ([P.132](#))
- Picture + Sound ([P.133](#))

Restoring Default Settings (Reset)

Camera settings can be easily restored to default settings. You can opt to reset almost all settings or only those directly related to photography.

1. Highlight **[Reset/Assign Custom Modes]** in  Shooting Menu 1 and press the **OK** button.
2. Highlight **[Reset]** and press the **OK** button.

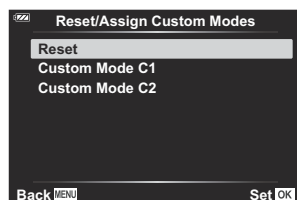

3. Highlight **[Full]** or **[Basic]**, and press the **OK** button.

Full	Reset all settings with a few exceptions, such as date/time setting and display.
Basic	Reset basic photography-related settings.

4. Highlight **[Yes]** and press the **OK** button.

Saving Settings (Assign to Custom Mode)

Frequently-used settings and shooting modes can be saved to custom modes (**C1**, **C2**) (P.52) and recalled for use as required simply by rotating the mode dial (P.52).

- At default settings, custom modes are equivalent to mode **P**.

Processing options (Picture Mode)

You can make individual adjustments to contrast, sharpness and other parameters via [\[Picture Mode\] \(P.71\)](#) settings. Changes to parameters are stored for each picture mode separately.

1. Select **[Picture Mode]** in  Shooting Menu 1 and press the **OK** button.

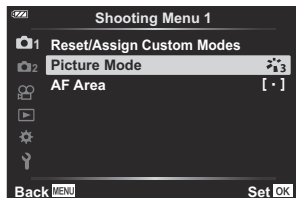

- The camera will display the picture mode available in the current shooting mode.

2. Highlight an option using the Δ ∇ buttons and press the **OK** button.

- Press \triangleright to set the detailed options for the selected picture mode. Detailed options are not available for some picture modes.

Sharpness	The outlines are enhanced to give the image a sharp, clear look.
Contrast	Adjust the difference between light and dark in the image. Accentuating the difference between light and dark can give the image a clear and powerful impression.
Saturation	Adjust the hues and color intensity of the image. Increasing the saturation produces an impactful image with clear tones.
Gradation	Adjust the hues and color intensity of the image. The overall image is brightened or darkened according to the impression of the subject. Both dark and light tones can be produced according to the contrast.
Color Filter	Color filter effects can be added to the [Monochrome] setting in Picture Mode. The subject can be brightened, or the contrast sharpened depending on the color. Contrast is sharpened in the order of yellow, orange, and red. Green is effective for portrait photography.
Monochrome Color	Color effects can be added to the [Monochrome] setting in Picture Mode.
Effect	Configure the intensity of the effect applied when Picture Mode is set to [i-Enhance] .
Add Effects	Art filters also allow you to set up frame effects and other effects.

 Changes to contrast have no effect when settings other than **[Normal]** are used.

Selecting the focusing area (AF Area)

You can select the position and size of the focus area for auto focus.

 (All Targets)	The camera automatically selects from the full set of focus targets.
[·] (Single Target)	You can select a single AF target.
Tracking	The camera tracks the subject movement automatically to focus on it continuously.

Setting the AF target (Area)

You can select the position of the AF target manually.

1. Select **[AF Area]** in  Shooting Menu 1 and press the **OK** button.
2. Highlight **[·]** and press the **OK** button.
3. Highlight the position of the AF target using the Δ ∇ \triangleleft \triangleright buttons and press the **OK** button.
 - Pressing and holding the **OK** button before setting the position returns the AF target to the center.

 To reposition the AF target when the camera is ready to shoot, press and hold the **OK** button.

 The number and size of the AF targets changes with the aspect ratio ([P.79](#)).

 The position of the AF target cannot be changed while the digital teleconverter is in use.

Continuously focusing on moving subjects (Tracking)

The camera can track the subject movement automatically to focus on it continuously.

1. Select **[AF Area]** in  Shooting Menu 1 and press the **OK** button.

2. Select **[Tracking]** and press the **OK** button.
3. Press the **MENU** button to return to the shooting display.
4. Align the AF target with the subject and press the **OK** button while keeping the shutter button pressed halfway.
5. When the subject is detected, the AF target will track its movement and automatically focus on it continuously.
 - To cancel the function, press the **OK** button.

⚠ The camera may be unable to stabilize the focus or track the subject depending on the subject and shooting conditions.

🔊 If the camera is unable to track the subject, the AF target will light up in red.

🔊 When using a digital teleconverter, AF target selection is fixed at **[L •]** (single target).

Shooting automatically with a fixed interval (Interval Shooting)

You can set the camera to shoot automatically with a set time lapse. The shot frames can also be recorded as a single movie.

1. Highlight **[Interval Shooting]** in  Shooting Menu 2 and press the **OK** button.

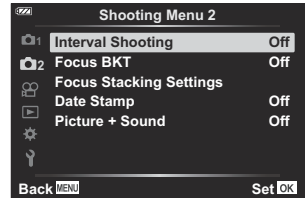

2. Highlight **[On]** and press **▷**.
3. Adjust the following settings and press the **OK** button.

Number of Frames	Choose the number of frames shot. [2]–[299] (frames)
Start Waiting Time	Choose how long the camera waits before starting interval-timer photography and taking the first shot. [00:00:00]–[24:00:00]
Interval Length	Choose how long the camera waits between shots once shooting has begun. [00:00:01]–[24:00:00]
Interval Mode	Choose whether the camera prioritizes taking photographs at the selected interval or taking the selected number of photographs. [Time Priority]/[Frames Priority] <ul style="list-style-type: none">• If [Time Priority] is selected, the previous exposure may not end before the next is due to begin. The final number of photographs may be less than that chosen for [Number of Frames] if, for example, [Interval Length] is very short or shooting for each interval takes a long time to complete.

<p>Exposure Smoothing</p>	<p>Adjust exposure to average out differences between shots. This smooths exposure changes during the time-lapse movie. [Off]/[On]</p>
<p>Time Lapse Movie</p>	<p>Choose whether to record a time-lapse movie. [Off]: The camera saves the individual shots but does not use them to create a time-lapse movie. [On]: The camera records the individual shots and also uses them to create a time-lapse movie.</p>
<p>Movie Settings</p>	<p>Choose the frame size ([Movie Resolution]) and frame rate ([Frame Rate]) for movies created using [Time Lapse Movie].</p> <p>The options available for [Movie Resolution] are: [4K], [FullHD], [HD]</p> <p>The options available for [Frame Rate] are: [30fps], [15fps], [10fps], [5fps]</p>

① The actual **[Start Waiting Time]**, **[Interval Length]** and **[Estimated Start Time]** may differ from the selected value depending on shooting settings. The values listed are for use as guidelines only.

4. Press the **OK** button repeatedly to return to  Shooting Menu 2.

- Press the **MENU** button to exit the menus.
- A  icon will appear in the shooting display (the icon shows the selected number of shots).



5. Release the shutter.



- The specified number of frames will be shot automatically.

- Time lapse shooting will be canceled if any of the following occurs:
 - The mode dial, **MENU** button, or  button are operated; or a USB cable is connected
- Turning the camera off ends interval-timer photography.

- ① The **[Image Review]** (P.139) option in the **Y** Setup Menu functions with a display time of 0.5 seconds.
- ① If the time until shooting or the shooting interval is 1 minute 31 seconds or longer, the monitor will go dark and the camera will enter sleep mode if no operations are performed for 1 minute. The display will turn on automatically 10 seconds before shooting for the next interval begins. It can also be reactivated by pressing the **ON/OFF** button at any time.
- ① No time lapse movie will be created if any frame is not recorded correctly.
- ① If there is insufficient space on the card, the time lapse movie will not be recorded.
- ① If there is not enough charge left on the battery, the shooting may end partway through. Use fully charged batteries, or use the USB-AC adapter to shoot for longer periods of time. If you are using the USB-AC adapter, insert the battery in the camera and select **[Charge]** in the dialog displayed after the USB cable is connected. Once the monitor has turned off, you can press the **ON/OFF** button to turn the monitor on again and continue to take pictures while charging is in progress.
- ① Time-lapse movies created at a size of **[4K]** may not display on some computer systems. More information is available on our website.

Varying focus little by little over a series of pictures (Focus BKT)

Each time the shutter button is pressed, the camera will automatically vary focus over a series of 10, 20, or 30 shots.

1. Select **[Focus BKT]** in  Shooting Menu 2 and press the **OK** button.
2. Highlight **[On]** and press .
3. Adjust the following settings and press the **OK** button.

Start Waiting Time	0 to 30 sec	Select the length of time the camera waits before shooting starts.
Set number of shots	10/20/30 (frames)	Select the number of frames in the bracketing sequence.
Set focus differential	Narrow/Normal/Wide	Select the amount by which the focus changes with each shot.

4. Press the shutter button halfway to focus.
 - If the focus indicator blinks, the camera is not in focus.
5. Press the shutter button all the way down to start shooting.

- The camera takes the number of shots selected for **[Set number of shots]** while varying focus with each shot. The camera will take pictures at the focus distance selected when the shutter button is pressed halfway, as well as distances in front of and behind it.
- The **[BKT]** indicator turns green during bracketing.
- Shooting ends when focus reaches ∞ (infinity).

 AF target selection is fixed at **[[·]]** (single target).



 Exposure and white balance are fixed at the values for the first shot in each series.



Increasing depth of field (Focus Stacking Settings)

Vary focus over the selected number of shots and combine the resulting pictures to form a single image. The camera records two pictures: the first shot taken and the composite image.

1. Highlight **[Focus Stacking Settings]** in  Shooting Menu 2 and press the **OK** button.
2. Adjust the following settings and press the **OK** button.

Start Waiting Time	Select the length of time the camera waits before shooting starts.
Set number of shots	Select the number of shots that will be taken and combined to create the final picture. <ul style="list-style-type: none">• The first shot is not included.

3. Rotate the mode dial to .
4. Highlight **[Focus Stacking]** using   and press the **OK** button.
5. Press the shutter button halfway to focus.
 - If the focus indicator blinks, the camera is not in focus.
 - To take a series of shots at the same focus distance, use focus lock (P.66) or MF (P.78).
6. Press the shutter button all the way down to start shooting.

-  AF target selection is fixed at **[[· ·]]** (single target).
-  Exposure and white balance are fixed at the values for the first shot in each series.



Date stamps (Date Stamp)

Stamp photos with the date and/or time of recording.



Off	Do not place date and time stamps on photos.
Date	Stamp photos with the date of recording.
Time	Stamp photos with the time of recording.
Date + Time	Stamp photos with the date and time of recording.

- The  icon is displayed when **[Date Stamp]** is enabled.

 Date/time stamps cannot be removed.





 This option will not be available if the date and time have not been set.  ["Initial Setup" \(P.28\)](#)

 This option is not available for:

- RAW pictures (including pictures shot using JPEG+RAW); movies; pictures recorded using **[e-Portrait]**, **[Handheld Starlight]**, **[Live Composite]**, **[Panorama]**, or **[Backlight HDR]** in **SCN** mode; pictures taken using **[Focus Stacking]** or **[Focus Bracketing]** in  mode; pictures taken using **[Underwater HDR]** in  mode; photos taken with **[ART]** selected for picture mode; photos taken with the mode dial rotated to ; pictures taken in burst mode; or photos created using the **[Edit]** option in the playback menu.

Picture + Sound

When set to **[On]**, the camera automatically records audio for 4 seconds after the shutter is released. This is useful when you want to record comments about the shot.

- The  icon is displayed when **[Picture + Sound]** is enabled.
 - The recorded audio can be played back using **[Play **] (P.101).
- ⓘ The **[Set number of shots]** setting for **[Custom Self-timer]** will be fixed at 1.
- ⓘ This option is not available for:
- Pictures taken using  mode; pictures recorded using **[e-Portrait]**, **[Handheld Starlight]**, **[Live Composite]**, **[Panorama]**, or **[Backlight HDR]** in **SCN** mode; pictures taken using **[Focus Stacking]** or **[Focus Bracketing]** in  mode; pictures taken using **[Underwater HDR]** in  mode; pictures taken using **[Interval Shooting]**

Using the Video Menu

The Video Menu

Movie recording functions are set in the Video Menu.

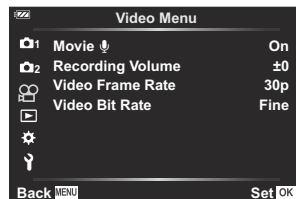

Option	Description
Movie	Adjust settings for recording sound while recording movies (P.54). [Off] : Record movies without sound. [On] : Record movies with sound. [On] : Record movies with sound; wind noise reduction enabled.
Recording Volume	Adjust the sensitivity of the built-in microphone. Adjust the sensitivity using Δ ∇ while checking the peak sound level picked up by the microphone over the previous few seconds.
Video Frame Rate	Select the frame rate for movie recording (P.82). <ul style="list-style-type: none">When shooting movies that will be viewed on a television, select a frame rate that matches the video standard used in the device, as the movie may not play back smoothly otherwise. Video standards vary by country or region: some use NTSC, others PAL.<ul style="list-style-type: none">When shooting for display on NTSC devices, select 60p (30p)When shooting for display on PAL devices, select 50p (25p)
Video Bit Rate	Select the compression rate for movie recording (P.82).

Operation sounds of the lens and camera may be recorded when recording a movie. To prevent these from being recorded, reduce the operation sounds by minimizing the button operations of the camera.

Sound is not recorded with high-speed movies or movies shot with ^{AR}T (Diorama) selected for picture mode.

When Movie Sound Recording is set to **[Off]**, is displayed.

Using the Playback Menu

The Playback Menu

Playback Menu

 (P.111)

 (P.136)

Edit (P.102)

Print Order (P.113)

Reset Protect (P.137)

Reset share Order (P.138)

Device Connection (P.174)

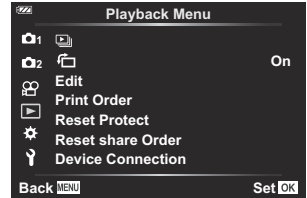

Automatically Rotating Portrait-Orientation Pictures for Playback (🔄)

If set to **[On]**, images in portrait orientation are automatically rotated to be displayed in the correct orientation on the playback display.

Removing Protection from All Pictures (Reset Protect)

Remove protection from multiple pictures simultaneously.

1. Highlight **[Reset Protect]** in the  Playback Menu and press the **OK** button.
2. Highlight **[Yes]** and press the **OK** button.

Cancelling a share order (Reset share Order)

Cancel share orders that are set on images.

1. Highlight **[Reset share Order]** in the  Playback Menu and press the **OK** button.
2. Highlight **[Yes]** and press the **OK** button.

Using the Setup Menu

The Setup Menu

Adjust basic camera settings. Examples include language selection and monitor brightness. The setup menu also contains options used during the initial setup process.



Option	Description
Card Setup	You can format the card or delete all images (P.141, P.142).
⌚ Settings (Date/time setting)	Set the date and time (P.28).
🗣️ (Changing the display language)	Choose a language for camera menus and guides displayed when configuring functions (P.143).
📺 (Monitor brightness adjustment)	You can adjust the brightness of the monitor. Highlight an option using the \triangle ∇ buttons.
Image Review	Choose whether pictures are automatically displayed after shooting. You can also configure how long the pictures are displayed. This is useful for a brief check of the picture you have taken. You can shoot the next shot by pressing the shutter button halfway even while the captured image is displayed on the monitor. [0.3sec] – [20sec] : Sets the length of time (seconds) to display the captured image on the monitor. [Off] : The captured image is not displayed on the monitor. [Auto ▶] : Displays the captured image, and then switches to playback mode. This is useful for erasing a picture after checking it.



Option	Description
Wi-Fi/Bluetooth Settings	Adjust settings for connection to Wi-Fi/ Bluetooth ®-compatible smartphones and optional remote controls using the camera's wireless function (P.180, P.172).
Construction Menu	Use and configure settings related to shooting construction photos (P.164).

Formatting the card (Card Setup)

Cards must be formatted with this camera before first use or after being used with other cameras or computers.

ⓘ All data stored on the card, including protected images, is erased when the card is formatted. When formatting a used card, confirm that there are no images that you still want to keep on the card.

👉 "Usable cards" (P.21)

1. Highlight **[Card Setup]** in the **Y** Setup Menu and press the **OK** button.

- A menu will be displayed if the card contains data. Highlight **[Format]** and press the **OK** button.

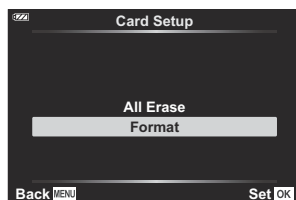

2. Highlight **[Yes]** and press the **OK** button.

- The card will be formatted.

Deleting all images (Card Setup)

All images on a card can be deleted at the same time. Protected images are not deleted.

1. Highlight **[Card Setup]** in the **Y** Setup Menu and press the **OK** button.

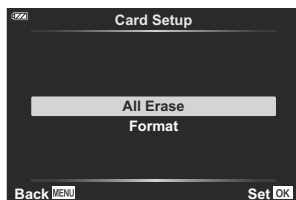

2. Highlight **[All Erase]** and press the **OK** button.
3. Highlight **[Yes]** and press the **OK** button.
 - All images are deleted.

Selecting a language

Select a different language for the menus and messages displayed in the monitor.

1. Highlight **[OK]** in the **Y** Setup Menu and press the **OK** button.
2. Highlight the desired language using the control dial or the **△ ▽ < ▷** buttons.



3. Press the **OK** button when the desired language is highlighted.

Using the Custom Menu

The Custom Menu

Camera settings can be customized using the  Custom Menu.

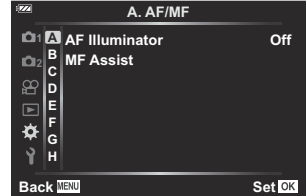

Custom Menu

- A** AF/MF (P.145)
- B** Disp/  /PC (P.146)
- C** Exp/ISO (P.147)
- D**  Custom (P.148)
- E**  /WB/Color (P.149)
- F** Record (P.151)
- G** Field Sensor (P.153)
- H**  Utility (P.154)

A AF/MF

MENU →  → **A**

Option	Description
AF Illuminator	Enable the AF illuminator to assist focus when lighting is poor. Select [Off] to disable the AF illuminator.
MF Assist	Enable MF assist to assist focusing during focus lock or manual focus (P.155).

MENU → → **B**

Option	Description
/Info Settings	<p>Select the information displayed when the INFO button is pressed (P.156).</p> <p>[Info]: Select the information displayed in full frame playback.</p> <p>[LV-Info]: Select the information displayed when the camera is in shooting mode.</p> <p>[Settings]: Select the information shown in the index and calendar displays.</p>
Live View Boost	<p>[Off]: Changes to settings such as exposure compensation are reflected in the display in the monitor.</p> <p>[On]: Changes to settings such as exposure compensation are not reflected in the display in the monitor; instead, brightness is adjusted to bring the display as close as possible to optimal exposure.</p>
Flicker Reduction	<p>Reduce the effects of flicker under some kinds of lighting, including fluorescent lamps. When flicker is not reduced by the [Auto] setting, set to [50Hz] or [60Hz] in accordance with the commercial power frequency of the region where the camera is used.</p>
Displayed Grid	<p>Select or to display a grid on the monitor.</p>
Peaking Color	<p>Select the color of the outlines (red, yellow, white, or black) in the focus peaking display when [MF Assist] is [On].</p>
(Beep sound)	<p>Use to adjust the volume of the sounds made in response to camera controls. Select "0" to disable sounds such as those made when the camera focuses or the shutter is released.</p>
HDMI	<p>Configure settings for HDMI connection (P.159).</p> <p>[Output Size]: Select the digital video signal format for connecting to a TV via an HDMI cable.</p> <p>[HDMI Control]: Select [On] to allow the camera to be operated using remotes for TVs that support HDMI control. This option takes effect when pictures are displayed on a TV.</p>



MENU →  → 

Option	Description
Exposure Shift	Adjust correct exposure separately for each metering mode. <ul style="list-style-type: none"> The effects are not visible in the monitor. To make normal adjustments to the exposure, perform exposure compensation (P.58).
ISO-Auto Set	<p>[Upper Limit / Default]: Select the upper limit and default value used for ISO sensitivity when [Auto] is selected for ISO.</p> <ul style="list-style-type: none"> [Upper Limit]: Select the upper limit for auto ISO sensitivity selection. [Default]: Select the default value for auto ISO sensitivity selection. <p>[Lowest S/S Setting]: Select the shutter speed below which the camera will automatically raise ISO sensitivity in modes P and A. If set to [Auto], the camera automatically sets the shutter speed.</p>
Noise Filter	Select the amount of noise reduction performed at high ISO sensitivities.
Noise Reduct.	<p>This function reduces the noise that is generated during long exposures.</p> <p>[Auto]: Noise reduction is performed at slow shutter speeds, or when the internal temperature of the camera has risen.</p> <p>[On]: Noise reduction is performed with every shot.</p> <p>[Off]: Noise reduction off.</p> <ul style="list-style-type: none"> The time required for noise reduction is shown in the display. [Off] is selected automatically during sequential shooting. This function may not work effectively with some shooting conditions or subjects.

Noise in images

While shooting at slow shutter speeds, noise may appear on screen. These phenomena occur when the temperature rises in the image pickup device or image pickup device internal drive circuit, causing current to be generated in those sections of the image pickup device that are not normally exposed to light. This can also occur when shooting with a high ISO setting in a high-temperature environment. To reduce this noise, the camera activates the noise reduction function.

MENU → ⚙ → **D**

Option	Description
 + 	When set to [On] , the exposure compensation value is added to the flash compensation value (P.58, P.85).
 + WB	Adjust white balance for use with flash. [Off] : The camera uses the value currently selected for white balance. [^{WB}AUTO] : The camera uses auto white balance ([^{WB}AUTO]). [WB⚡] : The camera uses flash white balance ([WB⚡]).

MENU → → **E**

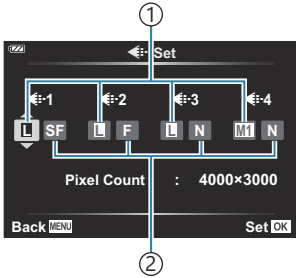
Option	Description
<p> Set</p>	<p>Change the image quality mode for JPEG images. You can choose from combinations of 4 image sizes and 3 compression rates (P.80, P.161).</p> <div style="border: 1px solid gray; padding: 10px; margin: 10px 0;"> <p>1. Highlight the image size and compression ratio from [-1] to [-4] using the buttons and adjust the value using the buttons.</p> <div style="display: flex; align-items: center;">  <div style="margin-left: 20px;"> <p>① Image size</p> <p>② Compression ratio</p> </div> </div> <p>2. Press the OK button. A confirmation dialog will be displayed.</p> </div>
<p>WB</p>	<p>Set the white balance. You can also fine-tune the white balance for each mode (P.75).</p> <div style="border: 1px solid gray; padding: 10px; margin: 10px 0;"> <p>1. Highlight the white balance option you wish to fine-tune and press .</p> <p>2. Highlight the A (amber–blue) or G (green–magenta) axis and use to select a value.</p> <ul style="list-style-type: none"> • Higher values on the A (amber–blue) axis give images a red cast, while lower values give images a blue cast. • Higher values on the G (green–magenta) axis heighten greens, while lower values give images a magenta cast. </div>
<p>WB AUTO Keep Warm Color</p>	<p>Select [On] to preserve “warm” colors in pictures taken under incandescent lighting.</p>

Option	Description
Color Space	<p>You can select a format to ensure that colors are correctly reproduced when shot images are regenerated on a monitor or using a printer.</p> <p>[sRGB]: This is a standard color space stipulated by an organization that establishes international standards. It is used in standard displays, printers, digital cameras, and various applications. In normal settings, use [sRGB] as the standard setting.</p> <p>[Adobe RGB]: This color space produces a wider color gamut than sRGB. Software and hardware such as a display, printer, etc. that are compatible with this standard are required for images to be output correctly. The first character of the file name will be displayed as an underscore () (e.g., _xxx0000.jpg).</p>

Option	Description
File Name	<p>Choose how the camera assigns file numbers.</p> <p>[Auto]: Even when a new card is inserted, the file numbers are retained from the previous card. File numbering continues from the last number used or from the highest number available on the card.</p> <p>[Reset]: When you insert a new card, the folder numbers starts at 100 and the file name starts at 0001. If a card containing images is inserted, the file numbers start at the number following the highest file number on the card.</p>
Edit Filename	<p>Choose how files are named when photos and movies are saved to the memory card. You can change the following portions of the file name.</p> <p>sRGB: Pmdd0000.jpg --- Pmdd Adobe RGB: _mdd0000.jpg --- mdd</p> <div style="border: 1px solid gray; padding: 10px;"><ol style="list-style-type: none">1. Highlight [sRGB] or [Adobe RGB] and press ▷.2. Use ◀▶ to move the cursor and △▽ to edit the highlighted character.<ul style="list-style-type: none">• Select [Off] to use the default prefixes.3. Repeat Step 2 as necessary to create the desired filename and then press the OK button.</div>

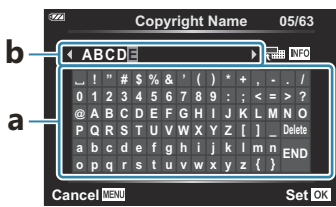
Option	Description
Copyright Settings	<p>Add the names of the photographer and copyright holder to new photographs. Names can be up to 63 characters long.</p> <p>[Copyright Info.]: Select [On] to include the names of the photographer and copyright holder in the Exif data for new photographs.</p> <p>[Artist Name]: Enter the name of the photographer.</p> <p>[Copyright Name]: Enter the name of the copyright holder.</p> <div style="border: 1px solid gray; padding: 10px; margin: 10px 0;"> <ol style="list-style-type: none"> 1. Select characters from a and press the OK button. The selected characters appear in b. 2. Repeat Step 1 to complete the name, then highlight [END] and press the OK button. <ul style="list-style-type: none"> • To delete a character, press the INFO button to place the cursor in b and highlight the character. After pressing the INFO button again to return to a, highlight [Delete] and press the OK button. </div>  <p>⚠ We do not accept liability for damages arising from disputes involving the use of [Copyright Settings]. Use at your own risk.</p>

Field Sensor

MENU → ⚙ → 

Option	Description
Record GPS location	Select [On] to record location data with pictures as they are taken.
Elevation/ Temperature	<p>Select the units used for temperature and altitude in the sensor data display. You can also calibrate altitude.</p> <p>[Calibrate Elevation]: Calibrate altitude when the current altitude and the value shown by the camera do not match.</p> <p>[m/ft]: Select whether altitude is shown in meters (m) or feet (ft).</p> <p>[°C/°F]: Select whether the temperature is displayed in degrees Celsius (°C) or degrees Fahrenheit (°F).</p> <div data-bbox="274 718 1030 885" style="border: 1px solid gray; padding: 10px;"><ol style="list-style-type: none">1. Highlight the desired item using $\Delta \nabla$.2. Press \triangleright.3. Highlight items using $\Delta \nabla$ and press the OK button to select.</div>



MENU → ⚙️ → H

Option	Description
Pixel Mapping	Perform simultaneous checks on the camera's image sensor and image processing functions (P.243).
Level Adjust	You can calibrate the angle of the level gauge. [Reset]: Reset the gauge to factory default settings. [Adjust]: Choose the current camera angle as the 0 position.
Sleep	Choose the delay before the camera enters sleep mode when no operations are performed. In sleep mode, camera operations are suspended and the monitor turns off. <ul style="list-style-type: none">• Normal operation can be restored by pressing a button or pressing the shutter button halfway.
Certification	Display certification icons.

Assist Manual Focus (MF Assist)

MENU →  →  → **[MF Assist]**

This feature is used to assist manual focus. If the focus position changes during focus lock or manual focus, the camera will enhance outlines or zoom the display in on an area of the frame.

Magnify	Magnifies a portion of the screen. <ul style="list-style-type: none">The subject in the center of the frame is displayed at a higher magnification. If you are using focus lock (P.66), the location on which focus is locked will be displayed at a higher magnification.
Peaking	Displays clearly defined outlines with edge enhancement. You can select the color of the outlines.  [Peaking Color] (P.146)

- When peaking is in use, the edges of small subjects tend to be enhanced more strongly. This is no guarantee of accurate focusing.
- Depending on the subject, outlines may be hard to see when **[On]** is selected for both **[Magnify]** and **[Peaking]**.

Adding information displays using the INFO button ([INFO] /Info Settings)

MENU → ⚙ → [B] → [INFO] /Info Settings]

▶ Info (Playback information displays)

Use [▶ Info] to add the following playback information displays. The added displays are displayed by repeatedly pressing the **INFO** button during playback. You can also opt to not show displays that appear at the default setting. 🖱️ ["Switching the information display" \(P.91\)](#)



Histogram display

A histogram showing the distribution of brightness in the image is displayed. The horizontal axis gives the brightness, the vertical axis the number of pixels of each brightness in the image.



Highlight & Shadow display

Areas above the upper limit of brightness for the image are shown in red, and those below the lower limit are shown in blue.



LV-Info (Shooting information displays)

Choose the info shown in the live view shooting display.  ["Switching the information display" \(P.33\)](#)

The histogram, Highlight & Shadow, and level gauge displays can be added to **[LV-Info]**. Select **[Custom 1]** or **[Custom 2]** and select the displays you wish to add. The added displays can be viewed by repeatedly pressing the **INFO** button during shooting. You can also opt to not show displays that appear at the default setting.

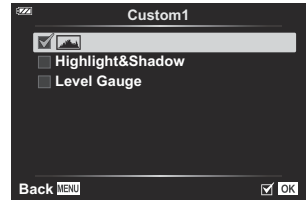

Level gauge display



The orientation of the camera is indicated. The "tilt" direction is indicated on the vertical bar and the "horizon" direction on the horizontal bar. The camera is level and plumb when the bars turn green.

- Use the indicators on the level gauge as a guide.
- Error in the display can be corrected via calibration ([P.154](#)).

Settings (Index/calendar display)

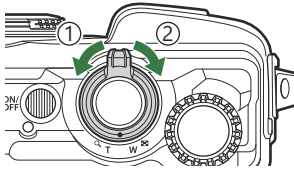
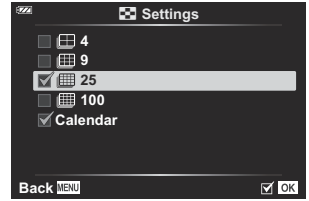
You can change the number of frames to be displayed on the index display and set to not display the screens that are set to be displayed by default with [ **Settings**]. The displays marked with a check can be viewed by rotating the zoom lever.



- ① Counterclockwise ( side)
- ② Clockwise ( side)

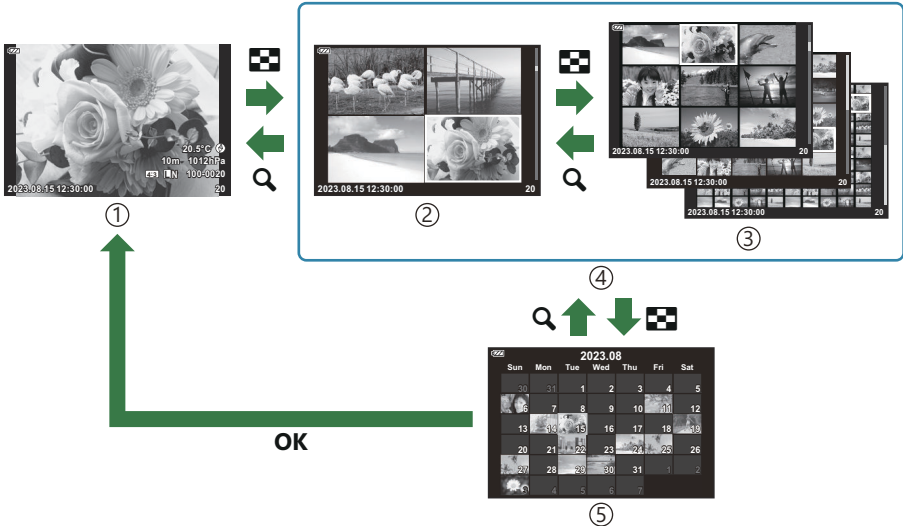

- ① Single-frame playback
- ② 4 frames
- ③ 9, 25, or 100 frames

- ④ Index display
- ⑤ Calendar display

Viewing camera images on TV (HDMI)

MENU → **⚙️** → **B** → **[HDMI]**

Use the separately sold cable with the camera to playback recorded images on your TV. This function is available during shooting. Connect the camera to an HD TV using an HDMI cable to view high-quality images on a TV screen.

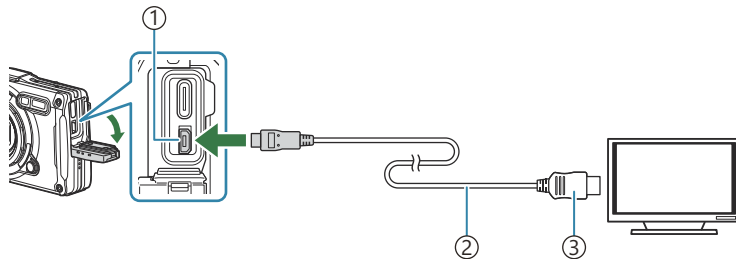

- ① HDMI connector (Type-D)
- ② HDMI cable
- ③ Type A

Connect the TV and camera and switch the input source of the TV.

- The camera monitor will turn off when an HDMI cable is connected.

🔗 For information on switching to HDMI input, see the manual provided with the TV.

🔗 If the camera is connected via an HDMI cable, you will be able to choose the digital video signal type. Match output settings to the input settings on the TV.

4K	If possible, the signal is output in 4K (3840 × 2160).
1080p	If possible, the signal is output in Full HD (1080p).
720p	If possible, the signal is output in HD (720p).
480p/576p	The signal is output in 480p/576p format.

- ⚠️ Depending on TV settings, the image may be cropped and some indicators may not be visible.
- ⚠️ Do not connect the camera to other HDMI output devices. Doing so may damage the camera.
- ⚠️ HDMI cannot be used while the camera is connected to a computer via USB.
- ⚠️ The output format used when **[4K]** is selected in photo mode is 1080p priority.

Using the TV remote control

The camera can be operated by a TV remote control when connected to a TV that supports HDMI control. Select **[On]** for **[HDMI Control]**. When **[On]** is selected, the camera can be used for playback only.

The camera monitor turns off.

- You can operate the camera by following the operation guide displayed on the TV.
- During single-frame playback, you can display or hide the information display by pressing the "Red" button, and display or hide the index display by pressing the "Green" button.

ⓘ Some televisions may not support all features.

Combinations of JPEG image sizes and compression rates (◀ Set)

MENU → **⚙** → **E** → [**◀ Set**]

You can set the JPEG image quality by combining image size and compression rate.

Image size (Pixel count)	Compression ratio			Application
	Super Fine	Fine	Normal	
Large (4000 × 3000)	L SF	L F	L N	Select for the print size
Middle1 (3200 × 2400)	M1 SF	M1 F	M1 N	
Middle2 (1920 × 1440)	M2 SF	M2 F	M2 N	
Small (1280×960)	S SF	S F	S N	For small prints and use on a website

Using the Construction Menus

Construction Menu

The following functions can be used when **[Construction Menu]** (P.164) is set to **[On]**.

- **[Construction]** in **SCN** mode (P.165)
- Configuring an image size for the Construction Menu (P.167)
- **[Displayed Grid]** in the Construction Menu (P.169)

Cautions

- This camera was developed, manufactured, and sold as a general-purpose camera. It has not been specifically designed to provide mechanical performance for a particular intended use.
- Since the camera's built-in GPS function and electronic compass function were not designed for use cases that require accuracy, there is no guarantee that the measured values (latitude, longitude, heading, temperature, etc.) are accurate.
- With the exception of the warranty set forth in our warranty policy, we will not compensate for any damages (including financial loss, interruption of work, loss of work or work information, or other time or monetary losses) resulting from the use of this product or the inability to use this product.

Displaying the Construction Menu

1. Press the **MENU** button to view the menus.
2. Highlight [**Construction Menu**] in the **Y** Setup Menu and press the **OK** button.
 [**Construction Menu**] cannot be set if the date and time are not set on the camera.

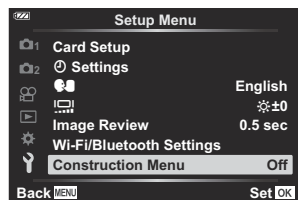

3. Highlight [**On**] and press **OK**.
4. Press the **MENU** button to exit the menus.

[Construction] in SCN mode

Shoot clear images by using the camera in a manner suited to the shooting location.

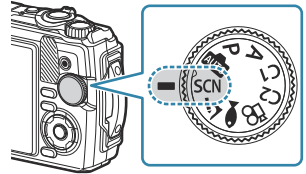

1. Rotate the mode dial to **SCN**.







2. Highlight **[Construction]** using the Δ ∇ \triangleleft \triangleright buttons and press the **OK** button.





3. Use \triangleleft \triangleright to highlight a scene mode and press the **OK** button.

	Construction 1	<p>Shoot standard construction photos. The phenomenon in which dust and rain appear as white dots on the image is reduced.</p> <ul style="list-style-type: none"> ☞ If you experience camera shake, using [Construction 2] may solve the problem. ☞ The maximum ISO sensitivity value is 3200.
	Construction 2	<p>Use this setting when pictures taken using [Construction 1] appear dark. This setting is less susceptible to camera shake. If you still experience camera shake when using [Construction 2], use a tripod.</p> <ul style="list-style-type: none"> ⚠ Images may appear grainy due to increased ISO sensitivity, so check the image to confirm that the image quality is suitable for the intended use. ☞ The maximum ISO sensitivity value is 6400.
	Construction 3	<p>Dark areas will appear brighter compared to [Construction 1], making this setting suitable for sites with significant variations in lighting.</p> <ul style="list-style-type: none"> ⚠ When shooting in bright locations, such as outdoors on a sunny day, the entire image may appear white. ☞ The maximum ISO sensitivity value is 1600.

	Indoor	This setting is suitable for shooting using flash in wide spaces. Images will appear bright from the foreground to the background.
	Slow Shutter	This setting is effective for shooting using a tripod at night. In addition, using the self-timer (P.60) will prevent camera shake when the shutter is released.
	Documents	This setting is suitable for shooting printed materials of A4 or A3 size, such as documents and drawings.
	Panorama	Shoot images with a wide angle of view.

4. Release the shutter.

 When shooting, you can lean against a wall or otherwise brace yourself to prevent blurring.

 Some functions cannot be selected when using **[Construction 1]**, **[Construction 2]**, or **[Construction 3]**.

 Flash is disabled when **[Construction 1]**, **[Construction 2]**, **[Construction 3]**, **[Slow Shutter]**, **[Documents]**, or **[Panorama]** are selected, preventing suitable images from being shot in places with no light at all. In such cases, select a **SCN** (scene) mode in which flash is enabled.

Configuring an image size for the Construction Menu



When **[Construction Menu]** is set to **[On]**, the image size (CAL S H/CAL S) and compression rate (N) for the Construction Menu can be set from Image quality for still pictures.

Configuring settings from Image quality for still pictures

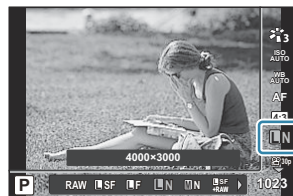
1. Press the **OK** button and then highlight  Image quality using $\Delta \nabla$.



2. Highlight $\frac{CALSH}{N}$ or $\frac{CAL S}{N}$ using $\triangleleft \triangleright$ and press the **OK** button.

 To use **[CAL S H]** or **[CAL S]** in combination with another compression rate (SF or F), change the settings in  **Set** (P.149).

 When **[Construction Menu]** is set to **[On]**, **M1** is displayed as **M**, **M2** is displayed as **CALSH**, and **S** is displayed as **CAL S**.

Configuring settings from the Shooting Menu (Easy CAL S)

When **[Easy CAL S]** is set to **[CAL S H]** or **[CAL S]**, an image quality for the Construction Menu is automatically selected when the camera is turned on.

1. Press the **MENU** button to view the menus.

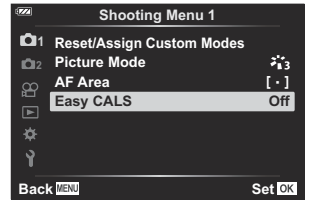

2. Select **[Easy CALS]** in  Shooting Menu 1 and press the **OK** button.



3. Highlight **[CAL S H]** or **[CAL S]** using the Δ ∇ buttons and press the **OK** button.
- When **[CAL S H]** is selected, $\frac{6456}{N}$ will be selected automatically when the camera is turned on.
 - When **[CAL S]** is selected, $\frac{945}{N}$ will be selected automatically when the camera is turned on.
 - When **[Off]** is selected, the image size and compression rate will be set to the settings that were in use immediately before the camera was turned off.
4. Press the **MENU** button to exit the menus.

ⓘ For the **[Panorama]** setting for **[Construction]** in **SCN** (Scene) mode, the size of the combined image may exceed approximately 3M (1920 × 1440), even when the image mode is set to **[CAL S H]** or **[CAL S]**.

[Displayed Grid] in the Construction Menu

When  is selected for **[Displayed Grid]**, an orange 25-segment grid guide will be displayed. When  is selected, a gray golden ratio grid guide will be displayed.

⚠ The histogram cannot be displayed while the orange 25-segment grid guide is displayed.

Connecting the Camera to External Devices

Connecting to External Devices

A number of tasks can be accomplished by connecting the camera to an external device such as a computer or smartphone.  ["Connecting to Smartphones" \(P.173\)](#), ["Copying Pictures to a Computer" \(P.183\)](#), ["Connecting the camera and remote control" \(P.186\)](#), ["Connecting the Camera to TVs or External Displays \(HDMI\)" \(P.192\)](#)

Cautions for the use of Wi-Fi and Bluetooth[®] functions

Disable wireless LAN and **Bluetooth**[®] in countries, regions, and locations where their use is prohibited.

The camera is equipped with built-in wireless LAN and **Bluetooth**[®]. Use of these features outside the country or region of purchase may violate local wireless regulations.

In certain countries and regions, it may be illegal to acquire position information without prior application to the government. Because of this, in certain sales regions, the camera may be set up not to display position information.

When taking the camera abroad, be aware that some regions or countries may have laws regulating the use of this function. Check the applicable laws in advance and abide by them when using the camera. Our company will not be held liable for the user's failure to comply with local regulations.

In airplanes and other places where the use of Wi-Fi is prohibited, disable this function.  [Disabling the Camera's Wireless Functions \(P.172\)](#)

- ⓘ Radio wave communications may be intercepted. Please be aware of this in advance.
- ⓘ The antenna used for transmitting and receiving data is located in the grip. Keep metal objects away as much as possible.
- ⓘ When carrying the camera in a bag or other container, its signal may be blocked by the material of the bag or other objects therein, which may prevent your camera from communicating with your smartphone.
- ⓘ The battery drains faster when the camera is connected to Wi-Fi. If the battery is low, communication may be interrupted even in the middle of transmission or reception.
- ⓘ Communication may be difficult or slow in areas where magnetic fields, static electricity, or radio waves are generated, such as near microwave ovens and cordless phones.
- ⓘ Some wireless LAN functions cannot be used when the card write-protect switch is set to the "LOCK" side.

Disabling the Camera's Wireless Functions

Disable the camera's wireless (Wi-Fi/**Bluetooth**[®]) functions.

1. Highlight **[Wi-Fi/Bluetooth Settings]** in the **Y** Setup Menu and press **▷**.
2. Select **[Wireless Functions]** and press **▷**.
3. Select **[Off]** and press the **OK** button.

 The following functions will be disabled.

- **[Device Connection]** (P.174), **[Bluetooth]** (P.176)

 To disable wireless connection standby and terminate wireless transmissions when the camera is turned on, select **[Off]** for **[Wi-Fi/Bluetooth Settings]** > **[Bluetooth]** in the **Y** Setup Menu.

 ["Wireless Connection Standby Setting for When the Camera Is On" \(P.176\)](#)

Connecting the Camera to a Smartphone

Connecting to Smartphones

Use the camera's wireless LAN (Wi-Fi) and **Bluetooth**[®] features to connect to a smartphone and use the dedicated app to make your experience more enjoyable both before and after shooting. Once a connection has been established, you can download and take pictures remotely and add position information to images.

- Operation is not guaranteed on all smartphones.

Things you can do with the designated app, OM Image Share

- **Download images from the camera to the smartphone**

Download pictures marked for sharing (P.107) to your smartphone.

You can also use the smartphone to select images for download from the camera.

- **Remote shooting from a smartphone**

You can remotely operate the camera and shoot using a smartphone.

- **Beautiful image processing**

Use intuitive controls to apply impressive effects to images downloaded to your smartphone.

- **Addition of GPS tags to camera images**



Using the smartphone's GPS function, you can add position information when taking pictures with the camera.

For details, visit our website.

Pairing the Camera and Smartphone



Follow the steps below when connecting the devices for the first time.

- Adjust pairing settings using the OM Image Share app, not the settings app included in the smartphone operating system.

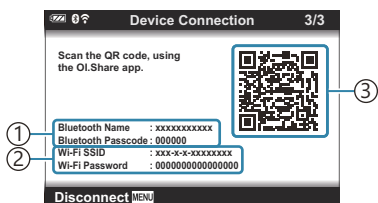
1. Launch the dedicated OM Image Share app that you installed on your smartphone in advance.
2. Select **[Device Connection]** in the  Playback Menu and press .
 - You can also start **[Device Connection]** by pressing and holding the **MENU** button when the camera is ready to shoot.
3. Follow the on-screen guide to adjust **Wi-Fi/Bluetooth** settings.
 - The **Bluetooth** local name and passcode, the Wi-Fi SSID and password, and a QR code are displayed in the monitor.



- ① **Bluetooth** local name
Bluetooth Passcode
- ② Wi-Fi SSID
Wi-Fi Password
- ③ QR code

4. Tap the camera icon at the bottom of the OM Image Share display.
 - The **[Easy Setup]** tab will be displayed.
5. Follow the on-screen instructions in OM Image Share to scan the QR code and adjust connection settings.
 - If you are unable to scan the QR code, follow the on-screen instructions in OM Image Share to adjust settings manually.
 - **Bluetooth:** To connect, select the local name and enter the passcode displayed in the camera monitor into the **Bluetooth** settings dialog displayed in OM Image Share.
 - Wi-Fi: To connect, enter the SSID and password displayed on the camera monitor into the Wi-Fi settings dialog displayed in OM Image Share.
 -  1 will be displayed when pairing is complete.
 - The **Bluetooth** [®] icon indicates the status as follows:
 - : The camera is emitting a wireless signal.
 - : Wireless connection has been established.

- 6.** To end the Wi-Fi connection, press **MENU** on the camera.
- You can also use OM Image Share to turn the camera off and end the connection.
 - At default settings, **Bluetooth**[®] is kept active even after the Wi-Fi connection is terminated, allowing you to shoot remotely with a smartphone. To set the camera to also terminate **Bluetooth**[®] connection when terminating the Wi-Fi connection, set **[Bluetooth]** to **[Off]**.

Wireless Connection Standby Setting for When the Camera Is On



You can choose whether the camera will be on standby for wireless connection with a smartphone or optional remote control when the power is on.



1. Highlight **[Wi-Fi/Bluetooth Settings]** in the **Y** Setup Menu and press **▷**.

2. Highlight **[Bluetooth]** and press **▷**.

ⓘ Pair the camera with the smartphone or optional remote control before proceeding. **[Bluetooth]** cannot be selected unless pairing has been completed.

3. Highlight the desired option and press the **OK** button.



Off	The camera will not be on standby for wireless connection and a wireless signal will not be emitted even when the power is on. For connection with a smartphone, start [Device Connection] (P.174) in the Playback Menu of the camera.
On 	When the camera is on, it will emit a wireless signal and be on standby for wireless connection. By operating OM Image Share, you can connect the camera to the smartphone and shoot remotely or transfer images.
On 	When the camera is turned on, it will start transmitting wireless signals, and if it has already been paired with an optional remote control (P.186), it will stand by for connection with the remote control.

- Because the options in the **[Bluetooth]** menu also serve to indicate **Bluetooth®** status, **[Stopped]** or **[Running]** will appear alongside the **[Off]**, **[On **], and **[On **]

ⓘ If the GPS track log is enabled in the dedicated OM Image Share app, location data downloaded from the app will be added to pictures taken while **[On **]

Transferring images to a smartphone

You can select images in the camera and load them to a smartphone. You can also use the camera to select images you want to share in advance.  "Selecting pictures for sharing (Share Order)" (P.107)

- If **[Off]** or **[On ** is selected for **[Bluetooth]** (P.176), select **[On **.
- Selecting **[On ** for **[Bluetooth]** (P.176) puts the camera on standby, ready for a wireless connection.

1. Tap **[Import Photos]** in OM Image Share on the smartphone.



- ① Depending on the smartphone, a confirmation screen for Wi-Fi connection may appear. Follow the on-screen guidance to connect the smartphone and the camera.
- The images in the camera are displayed in a list.

2. Select the pictures you want to transfer and tap the Save button.

- When saving is completed, you can turn off the camera from the smartphone.
- **[Import Photos]** can be used to download pictures to smartphones connected via the **[Device Connection]** option in the camera menus even when **[Off]** or **[On ** is selected for **[Bluetooth]** (P.176).

Shooting remotely with a smartphone (Live View)

You can shoot remotely by operating the camera with a smartphone while checking the live view on the smartphone screen.

- The camera shows the connection screen and all operations are performed from the smartphone.
- If **[Off]** or **[On  is selected for **[Bluetooth]** (P.176), select **[On .****
- Selecting **[On  for **[Bluetooth]** (P.176) puts the camera on standby, ready for a wireless connection.**

1. Launch OM Image Share and tap **[Remote Control]**.

2. Tap **[Live View]**.



3. Tap the shutter button to shoot.

- The image taken is saved on the memory card in the camera.

- **[Live View]** can be used to take pictures from smartphones connected via the **[Device Connection]** (P.174) option in the camera menus even when **[Off]** or **[On  is selected for **[Bluetooth]** (P.176).**
- Available shooting options are partially limited.

Shooting remotely with a smartphone (Remote Shutter)

You can shoot remotely by operating the camera with a smartphone (Remote Shutter).

- All operations are available on the camera. In addition, you can shoot pictures and record movies using the shutter button displayed on the smartphone screen.
- If **[Off]** or **[On ** is selected for **[Bluetooth]** (P.176), select **[On **.
- Selecting **[On ** for **[Bluetooth]** (P.176) puts the camera on standby, ready for a wireless connection.

1. Launch OM Image Share and tap **[Remote Control]**.

2. Tap **[Remote Shutter]**.

3. Tap the shutter button to shoot.

- The image taken is saved on the memory card in the camera.

- **[Remote Shutter]** can be used to take pictures from smartphones connected via the **[Device Connection]** (P.174) option in the camera menus even when **[Off]** or **[On ** is selected for **[Bluetooth]** (P.176).

Resetting wireless LAN/Bluetooth® settings

To restore **[Wi-Fi/Bluetooth Settings]** to default values:

1. Highlight **[Wi-Fi/Bluetooth Settings]** in the **Y** Setup Menu and press **▷**.
2. Highlight **[Reset Settings]** and press **▷**.
3. Select **[Yes]** and press the **OK** button.





 The following settings will be reset:

- **[Wireless Functions]** (P.172), **[Bluetooth]** (P.176), and **[Connection Password]** (P.181)

 Resetting wireless settings ends pairing between the camera and smartphones. Before connecting to a smartphone, you will need to pair the devices again (P.174). Resetting wireless settings also ends pairing between the camera and remote controls. Before connecting to a remote control, you will need to pair the devices again (P.186).

Changing the password

To change the password for smartphone connections:

1. Highlight **[Wi-Fi/Bluetooth Settings]** in the  Setup Menu and press .
2. Highlight **[Connection Password]** and press .
3. Press the  button as directed by the on-screen guide.
 - A new password will be set.

- You can change both password for smartphone connections and **Bluetooth®** connection passcode.
- Reconnect to the smartphone after changing passwords.  ["Pairing the Camera and Smartphone" \(P.174\)](#)

Connecting the Camera to a Computer

Connecting the Camera to a Computer

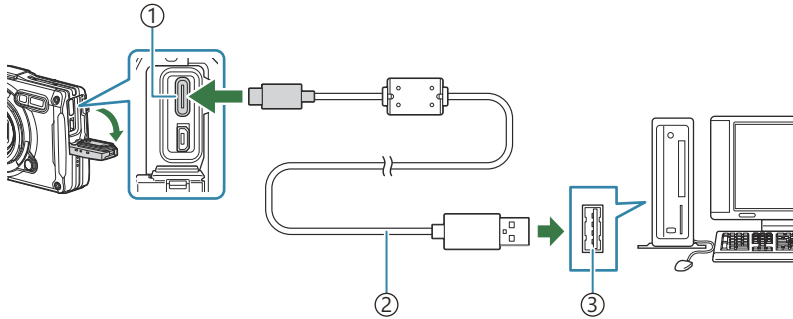

- ① USB connector (Type-C)
- ② USB cable (supplied)
- ③ USB port

- When the camera is connected to a computer via USB, a dialog should be displayed in the monitor prompting you to select a host.
- ⚠ The battery can be charged while the camera is connected to the computer via USB. The charging time varies depending on the performance of the computer. (There may be cases in which it takes approx. 10 hours.)
- ⚠ If nothing is displayed on the camera screen even after connecting the camera to the computer, the battery may be exhausted. Use a fully charged battery.
- ⚠ Data transfer is not guaranteed in the following environments, even if your computer is equipped with a USB port.
 - Computers with a USB port added by means of an extension card, etc., computers without a factory-installed OS, or home-built computers
- ⚠ Camera controls cannot be used while the camera is connected to a computer.
- ⚠ If the computer does not detect the camera, disconnect the USB cable and then reconnect it to the computer.

Copying Pictures to a Computer

1. Turn the camera off and connect it to the computer.
 - The location of the USB port varies with the computer. For details, refer to your computer's manual.
 - The selection screen for the USB connection is displayed.

2. Highlight **[Storage]** or **[MTP]** using Δ ∇ . Press the **OK** button.

- **[Storage]**: Connect the camera as a card reader.
- **[MTP]**: Connect the camera as a portable device.

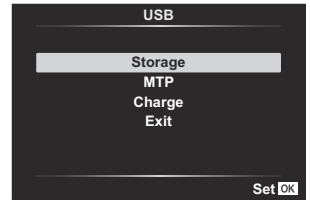

3. Copy pictures to the computer as soon as the computer recognizes the camera as a new device.

Installing the PC software

Install the following software to access the camera while it is connected directly to the computer via USB.

OM Workspace

This computer application is used to download and view photos and movies recorded with the camera. It can also be used to update the camera firmware. The software can be downloaded from our website. Be prepared to provide the camera serial number when downloading the software.

Using the Remote Control

Names of parts

RM-WR1

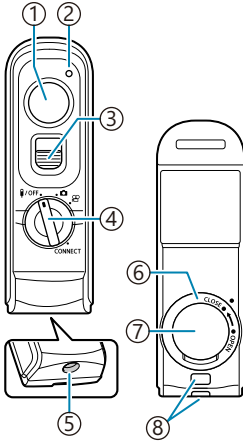

- ① Shutter button
- ② Data transfer indicator
- ③ Shutter button lock
- ④ Mode dial (OFF / CAMERA / VIDEO / CONNECT)
- ⑤ Cable connector
- ⑥ Battery compartment lid
- ⑦ Battery compartment cover
- ⑧ Strap eyelet

Connecting the camera and remote control

Wireless connection

For wireless connection, you must pair the camera and the remote control first.

1. Highlight **[Wi-Fi/Bluetooth Settings]** in the **⌂** Setup Menu and press **▷**.
2. Highlight **[Wireless Shutter Setting]** and press **▷**.
3. Highlight **[Start Pairing]** and press the **OK** button.

4. When a message is displaying stating that pairing is in progress, rotate the mode dial on the remote control to **CONNECT** and keep it in this position.

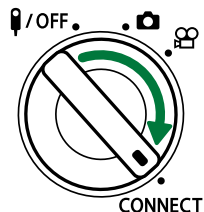
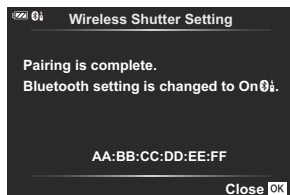

- Pairing starts when it is kept in this position for 3 seconds. Keep it in the **CONNECT** position until pairing is complete. If you rotate the mode dial before it is complete, the data transfer indicator flashes rapidly.
- The data transfer indicator lights when pairing starts.

5. When a message indicating that pairing is complete is displayed, press the **OK** button.

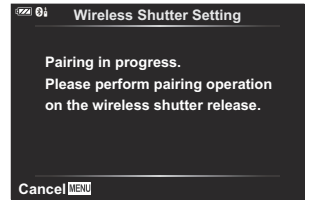





- The data transfer indicator turns off when pairing is complete.
 - **[Bluetooth]** (P.176) will automatically be set to **[On*0*i]** when pairing is complete.
- ⓘ If you rotate the mode dial of the remote control or press the **MENU** button of the camera before the pairing completion message is displayed, the pairing process ends. Paired device information will be reset. Pair the devices again.
- ⓘ If you rotate the mode dial of a remote control that is not currently paired to **CONNECT** and keep it in this position for 3 seconds, or if pairing fails, the pairing information from previous connections will be reset. Pair the devices again.

Deleting pairing

1. Highlight **[Wi-Fi/Bluetooth Settings]** in the **Y** Setup Menu and press **▷**.
 2. Highlight **[Wireless Shutter Setting]** and press **▷**.
 3. Select **[Delete Pairing]** and press the **OK** button.
 4. Select **[Yes]** and press the **OK** button.
- ⓘ If you have paired the camera with a remote control, you will need to perform **[Delete Pairing]** to reset pairing information before you can pair the camera with a new remote control.

Shooting from the remote control

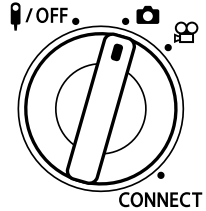

Before establishing a wireless connection between the camera and remote control, confirm that **[On **] is selected for **[Bluetooth]** (P.176). When set to **[On **],  appears in the display and the camera will be on standby for wireless communication with the remote control as soon as it is turned on.

1. Rotate the mode dial of the remote control to  or .



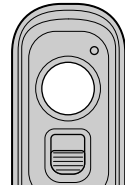







2. Press the shutter button on the remote control to take pictures.



- When the mode dial of the remote control is set to  (still photography mode): When you lightly press the shutter button of the remote control down to the first position (press the shutter button halfway), the AF confirmation mark (●) will be displayed, and a green frame (AF target) will be displayed in the focus location.
- When the mode dial of the remote control is set to  (movie recording mode): When you press the shutter button of the remote control, movie recording starts. Press the shutter button of the remote control again to stop movie recording.

Data transfer indicator of the remote control

Lights once	Remote control operation is sent to the camera correctly.
Flashes rapidly (1 second)	Remote control operation is not sent to the camera correctly. Shorten the distance between the camera and the remote control. If the problem is not solved, check the setting of the camera.
Flashes rapidly (3 seconds)	There is a problem with the pairing of the camera and remote control. Pair the devices again.
Does not light	This may occur in the following situations. <ul style="list-style-type: none">• The battery in the remote control is dead.• The mode dial of the remote control is in the /OFF position.• The camera and remote control are connected with a cable.

- ① You can connect to smartphones via **[Device Connection]** (P.174) even when **[On **] is selected for **[Bluetooth]** (P.176). However, you cannot control the camera from the remote control when it is connected to a smartphone.
- ① Pairing and remote photography are not available when **[Off]** is selected for **[Wireless Functions]** (P.172).
- ① The camera does not enter sleep mode when a remote control is connected wirelessly.
- ① The camera will, however, enter sleep mode in accordance with the option selected for **[Sleep]** if the mode dial on the remote control is in the /OFF position.  **Custom Menu**  > **[Sleep]** (P.154)
- ① The camera will not enter sleep mode when **[On **] is selected for **[Bluetooth]** (P.176) unless the mode dial on the remote control is in the /OFF position.
- ① If you operate the remote control while the camera is in sleep mode, it may take a longer time for the camera to resume operation.
- ① The camera cannot be controlled from the remote control while it is waking from sleep. Operate the remote control after the camera has resumed operation.
- ① Rotate the mode dial of the remote control to the /OFF position when you have finished using the remote control.

MAC address of the remote control

The MAC address of the remote control is printed on the warranty card provided with the remote control.

Precautions for using the remote control

- Do not tug on the battery compartment cover or use it to turn the battery compartment lid.
- Do not pierce batteries with sharp objects.
- Confirm that the battery compartment lid is free of foreign matter before closing it.

Connecting to TVs or External Displays via HDMI

Connecting the Camera to TVs or External Displays (HDMI)

Pictures can be displayed on televisions connected to the camera via HDMI. Use the television to display pictures to an audience. The TV remote can be used to control the display while the television is connected to the camera. No app or other software is required.

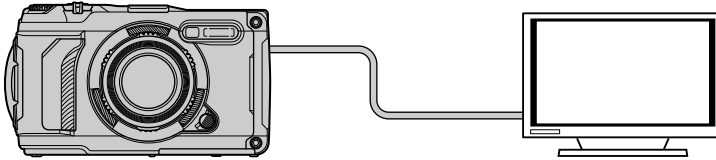

You can also film movies while the camera is connected to an external monitor or video recorder via HDMI.

⚠ HDMI cables are available from third-party suppliers. Use an HDMI-certified cable.

Viewing Pictures on a TV (HDMI)

Photos and movies can be viewed on a high-definition TV connected directly to the camera by means of an HDMI cable. A remote control can be used to operate the display while it is connected to the camera.

HDMI Output

Choose the signal output to the HDMI device. You can adjust movie frame size and frame rate to match TV specifications and the video standards supported in your country or region. Match output settings to the input settings on the TV.

Output Size	The format for the video signal output via the HDMI connector can be chosen from the options below. [4K] : 4K (3840 × 2160) priority [1080p] : Full High Definition (1080p) priority [720p] : High Definition (720p) priority [480p/576p] : 480p/576p
HDMI Control	The television remote control can be used to operate the camera in playback mode (P.196). Choose from [Off] and [On] . When [On] is selected, the camera can be used for playback only.

- **[HDMI Control]** settings cannot be changed while the camera is connected to another device via HDMI.
- Audio can be output only on devices that support the audio format selected with the camera.
- The options available via **[HDMI Control]** vary with the device connected. See the device manual for details.

1. Press the **MENU** button to view the menus.

2. Display  Custom Menu **[B]** (Disp/■)/PC).

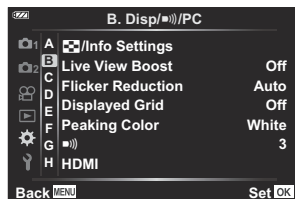

3. Highlight **[HDMI]** using the Δ ∇ buttons and press the \triangleright button.

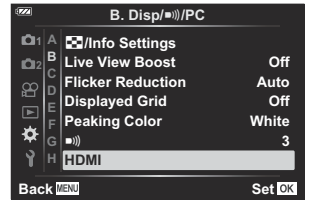

4. Highlight an item using the Δ ∇ buttons and press the \triangleright button.

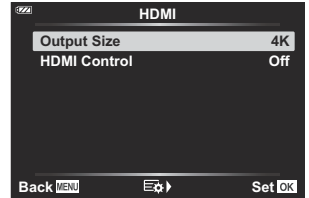

5. Highlight the desired option using the Δ ∇ buttons and press the **OK** button.

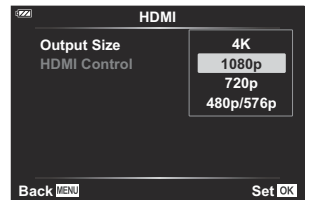

- Repeat Steps 4 and 5 as required.

6. Press the **MENU** button repeatedly to exit the menu.

Connecting the Camera to a TV

Connect the camera using an HDMI cable.

1. After confirming that the camera is off, connect it to the TV using an HDMI cable.

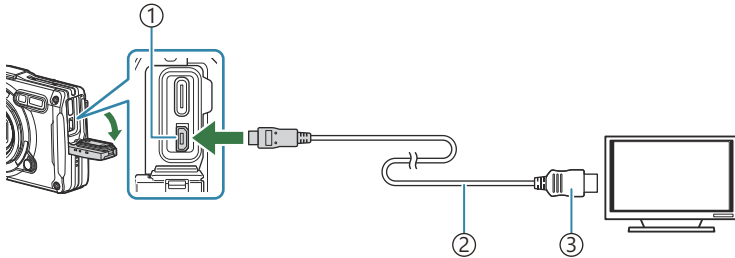



- ① HDMI connector (Type-D)
- ② HDMI cable
- ③ Type A

2. Switch the TV to HDMI input and turn the camera on.

- The TV will show the content of the camera monitor. Press the  button to view pictures.

 If **[On]** is selected for **[HDMI Control]** (P.196), the camera monitor will turn off when an HDMI cable is connected.

 For information on switching to HDMI input, see the manual provided with the TV.

 Depending on TV settings, the image may be cropped and some indicators may not be visible.

 HDMI cannot be used while the camera is connected to a computer via USB.

 The output format used when **[4K]** is selected in photo mode is 1080p priority.

Operating the camera using a TV remote control

A remote control can be used to operate the display while the camera is directly connected to the TV using an HDMI cable.

- The TV must support HDMI Control. See the device manual for details.

On	The television remote control can be used to operate the camera in playback mode. When [On] is selected, the camera can be used for playback only.
Off	The television remote control cannot be used to operate the camera. Information will only be displayed on the TV screen.

1. Press the **MENU** button to view the menus.
2. Select **[HDMI]** in **⚙ Custom Menu B (Disp/■)/PC**, then press the **▶** button.
3. Highlight **[HDMI Control]** using the **△ ▽** buttons and press the **▶** button.
4. Highlight **[On]** using the **△ ▽** buttons and press the **OK** button.
5. Press the **MENU** button repeatedly to exit the menu.

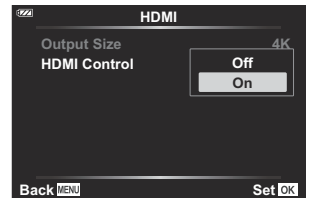
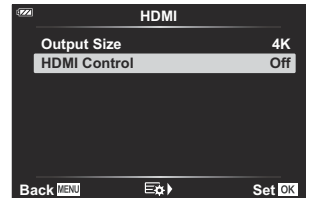
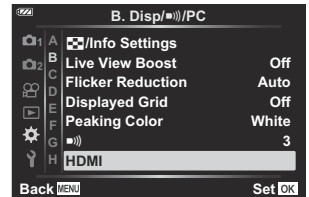

6. Connect the camera to the TV using an HDMI cable.

- Use the TV remote control for operation. You can operate the camera by following the operation guide displayed on the TV.
- During single-frame playback, you can display or hide the information display by pressing the “Red” button, and display or hide the index display by pressing the “Green” button.

ⓘ Some televisions may not support all features.

ⓘ The camera monitor turns off while the content is displayed on the TV.

Using Field Sensor Data

Field Sensor





The camera can log data on position, altitude, and other data acquired via GPS, as well as data from temperature and pressure sensors. These data can also be recorded with photographs. Logs can be viewed using the OM Image Share smartphone app.

Visit our website for information about OM Image Share.

- The camera also supports the Quazi-Zenith Satellite System (QZSS) and GLONASS.
- Latitude and longitude are displayed on images to which position information has been added.
- The camera is not equipped for GPS navigation.
- Be sure to use the latest version of the app.

GPS and other data displays

These displays are not intended for applications that require a high degree of precision, and the accuracy of the data (latitude and longitude, heading, altitude, temperature, etc.) they provide is not guaranteed. The accuracy of these displays may be also affected by factors not under the control of the manufacturer.

 Altitude can be adjusted in Custom Menu  [Elevation/Temperature].   Custom Menu
 > [Elevation/Temperature] (P.153)

GPS: Precautions for use

- Before using the GPS function, read "[GPS function, electronic compass](#)" (P.200).
- In certain countries and regions, it may be illegal to acquire position information without prior application to the government. Because of this, in certain sales regions, the camera may be set up not to display position information. When taking the camera abroad, be aware that some regions or countries may have laws regulating the use of this function. Be sure to abide by all local laws.
- Before boarding an aircraft or entering other locations where the use of GPS devices is prohibited, be sure to rotate the LOG switch to **OFF** and select **[Off]** for both [\[Record GPS location\]](#) (P.153) and [\[Auto Time Adjust\]](#) in [\[ⓘ Settings\]](#) (P.139).

GPS function, electronic compass

- In locations with limited overhead clearance (inside buildings, underground, underwater, in forests, near high buildings) or in locations subject to strong magnetic or electric fields (near new high-voltage power lines, magnets or electrical goods, 1.5GHz mobile telephones), it may not be possible to determine measurements or errors may occur.
- The altitude displayed on the measurement information screen or picture playback screen etc. is displayed and recorded based on information from pressure sensors built into the camera body. Please be aware that the displayed altitude is not based on GPS location data.
- Electronic compass errors may be caused by the effects of strong magnetic or electrical fields (such as televisions, microwaves, large motors, radio towers and high-voltage lines). To restore the electronic compass function, hold the camera firmly and rotate it in a figure-eight motion while turning your wrist.
- Since the GPS function and electronic compass function are not required to be accurate, there is no guarantee that the measured values (latitude, longitude, compass direction, altitude, temperature, etc.) are accurate.
- If your model is equipped with GPS and Wi-Fi functions, contact the service center in your country or region in advance, as the repair service may not be available in some countries or regions due to local laws and regulations.

Before using GPS function (A-GPS data)

Depending on the status of the camera and communication, it may take time to acquire the position information. When the A-GPS is used, the position determination time can be shortened from a few seconds to a few tens of seconds. Download A-GPS data using OM Image Share, the dedicated smartphone app, or OM Workspace, an image management and editing program for PCs, and write the data to the camera.

Make sure that the camera's date and time settings are set correctly in advance.

- ⚠ A-GPS data must be updated every 4 weeks. Use the newest possible A-GPS data since the time to acquire position information could take longer as time has elapsed after the last update.
- ⚠ The provision of A-GPS data may be terminated without prior notice.

Updating the A-GPS data using a smartphone

Install the dedicated smartphone app OM Image Share in advance. Refer to our website for details on how to update the A-GPS data.

Updating the A-GPS data using a PC

Download the OM Workspace software and install it on your PC in advance. Refer to our website for details on how to update the A-GPS data.

Using GPS

Any of the following enable GPS:

- Rotating the LOG switch to **LOG** (P.203), setting **[Record GPS location]** (P.153) to **[On]**, setting **[Auto Time Adjust]** in **[⚙ Settings]** (P.139) to **[On]**

⚠ Do not cover the GPS antenna (P.15) with your hands or metal objects.

⚠ If you are using the GPS function for the first time and the A-GPS has not been updated, or if the function has not been used for a long time, it may take a few minutes for the position measurement to end.

📶 If the GPS icon is displayed, GPS information is being acquired. It indicates that some error has occurred when the icon is shown in red. Contact our service center if the error persists after the camera is turned off and on.

Recording and Saving Logs

While the LOG switch is in the **LOG** position, the camera will log GPS and other sensor data (P.198). Logs can be viewed using the OM Image Share smartphone app.

Recording logs

Rotate the **LOG** switch to LOG.

- Logging will start. The indicator lamp will blink while logging is in progress.
 - Logging ends automatically when the battery runs low (P.249).
- ⚠ In LOG mode, the camera draws on the battery continuously to acquire location data.
- ⚠ No data can be added to the log once the memory allocated to temporary log storage is full (P.249), in which case you will need to rotate the LOG switch to **OFF** to save the log to the card.

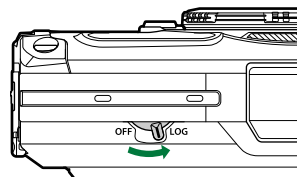

Saving logs

The current log is saved to the card when the LOG switch is rotated to **OFF**. Log files are recorded to the "GPSLOG" and "SNSLOG" folders on the card (P.22).

- ⚠ A message is displayed in the monitor while the log is being saved. Do not remove the card until the message has cleared from the display. Removing the card while the log is being saved could cause loss of the log file or camera or card malfunction.
- ⚠ The camera may not begin saving the log to the card when the LOG switch is rotated to **OFF** if, for example, wireless data transfer is in progress or the card is full or write-protected, in which case you should terminate wireless data transfer, delete unwanted data from the card, or otherwise enable the log to be saved. Do not remove the battery from the camera until the log has been saved.
- ⚠ The log will not be saved if no card is inserted.
- ⚠ Logs will not be saved if the battery is low. Charge the battery.
- ⚠ Each card can store up to 199 log files. An error message will be displayed when the log file count approaches this number. Should this occur, insert another card or delete log files after copying them to a computer. 📖 "Error codes" (P.249)

Using Buffered and Saved Logs

To use the logs, the logs stored on the card must be transferred to OM Image Share, the dedicated smartphone app. Connect to your smartphone using the camera's wireless LAN function ([P.174](#)).

Things you can do with the designated app, OM Image Share

- Logs stored on the card and images shot while recording logs can be transferred to your smartphone.
- Transferred logs can be loaded and viewed as tracks.
- Transferred logs can be linked to images for viewing and management.

For details, visit our website.

Viewing Location Data

Pressing the **INFO** button when the camera is off displays location data in the monitor.

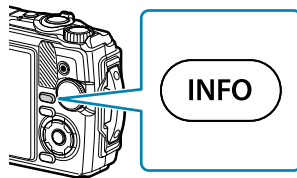

⚠ The accuracy of the data displayed varies with weather conditions and other factors. The values listed are for use as guidelines only.

Location data displays



- ① Time
- ② Log recording in progress
- ③ Direction information
- ④ Temperature (water temperature)
- ⑤ Atmospheric pressure
- ⑥ Altitude (depth)
- ⑦ GPS icon
- ⑧ Latitude
- ⑨ Longitude

Latitude and longitude

If the GPS icon blinks or is not displayed, the camera is unable to determine the current position.

GPS and other data displays









These displays are not intended for applications that require a high degree of precision, and the accuracy of the data (latitude, longitude, heading, depth, temperature, etc.) provided is not guaranteed. The accuracy of these displays may be also affected by factors not under the control of the manufacturer.







Shooting Modes and Default Settings

List of configurable shooting modes









 / **P/A** /  /  /  Mode

*1: Some settings are unavailable.

		P	A				
						Focus BKT	
Exposure compensation	—	✓	✓	✓	✓	✓	✓
Picture mode	—	✓	✓	*1	*1	*1	*1
ISO sensitivity	—	✓	✓	✓	✓	✓	✓
White balance	—	✓	✓	✓	✓	✓	✓
AF mode	—	✓	✓	*1	*1	*1	*1
Aspect ratio	✓	✓	✓	✓	✓	✓	—
 Image quality	✓	✓	✓	✓	*1	✓	✓
 Movie quality	✓	✓	✓	✓	✓	✓	✓
 Image stabilizer	—	✓	✓	✓	✓	✓	✓
 Image stabilizer	—	—	—	—	—	—	—
Flash	*1	✓	✓	*1	*1	*1	*1
Flash intensity control	—	✓	✓	✓	✓	✓	✓
Sequential shooting/Self-timer	*1	✓	✓	✓	*1	*1	✓
Metering	—	✓	✓	✓	✓	✓	✓

	AUTO	P	A				
							
Face priority	—	✓	✓	—	—	—	—
Accessory	*1	✓	✓	*1	*1	*1	*1
Reset/Assign Custom Modes	✓	✓	✓	✓	✓	✓	✓
AF Area	✓	✓	✓	—	—	—	—
Easy CALS	✓	✓	✓	✓	✓	✓	✓
Interval Shooting	—	✓	✓	✓	—	—	✓
Focus BKT	—	✓	✓	—	—	✓	—
Focus Stacking Settings	✓	✓	✓	✓	✓	✓	✓
Date stamp	✓	✓	✓	✓	—	—	✓
Picture + Sound	—	✓	✓	✓	—	—	✓
Movie 	✓	✓	✓	✓	✓	✓	✓
Recording Volume	✓	✓	✓	✓	✓	✓	✓
Video Frame Rate	✓	✓	✓	✓	✓	✓	✓
Video Bit Rate	✓	✓	✓	✓	✓	✓	✓

						
						
Exposure compensation	✓	✓	✓	✓	✓	✓
Picture mode	—	—	—	—	—	*1
ISO sensitivity	—	—	—	—	—	—
White balance	✓	✓	✓	✓	✓	✓
AF mode	*1	*1	*1	*1	*1	✓
Aspect ratio	✓	✓	✓	✓	✓	—
 Image quality	✓	✓	✓	✓	*1	✓
 Movie quality	✓	✓	✓	✓	✓	✓
 Image stabilizer	✓	✓	✓	✓	✓	—
 Image stabilizer	—	—	—	—	—	*1
Flash	*1	*1	*1	*1	—	—
Flash intensity control	✓	✓	✓	✓	—	—
Sequential shooting/Self-timer	*1	*1	*1	*1	—	*1
Metering	—	—	—	—	—	—
Face priority	—	—	—	—	—	*1
Accessory	*1	*1	*1	*1	*1	*1
Reset/Assign Custom Modes	✓	✓	✓	✓	✓	*1
AF Area	✓	✓	✓	—	✓	✓
Easy CALS	✓	✓	✓	✓	✓	✓
Interval Shooting	—	—	—	—	—	—

						
						
Focus BKT	—	—	—	—	—	—
Focus Stacking Settings	✓	✓	✓	✓	✓	✓
Date stamp	✓	✓	✓	✓	—	—
Picture + Sound	✓	✓	✓	✓	—	✓
Movie 	✓	✓	✓	✓	✓	*1
Recording Volume	✓	✓	✓	✓	✓	*1
Video Frame Rate	✓	✓	✓	✓	✓	*1
Video Bit Rate	✓	✓	✓	✓	✓	*1

SCN mode

*1: Some settings are unavailable.







								
Exposure compensation	—	✓	—	—	—	—	—	—
Picture mode	—	—	—	—	—	—	—	—
ISO sensitivity	—	—	—	—	—	—	—	—
White balance	—	—	—	—	—	—	—	—
AF mode	—	—	—	—	—	—	—	—
Aspect ratio	✓	✓	✓	✓	✓	✓	✓	✓
 Image quality	✓	*1	✓	✓	✓	✓	*1	✓
 Movie quality	*1	*1	*1	*1	*1	*1	*1	*1
 Image stabilizer	✓	✓	✓	✓	✓	✓	✓	✓
 Image stabilizer	—	—	—	—	—	—	—	—
Flash	*1	*1	*1	*1	*1	—	—	—
Flash intensity control	—	—	—	—	—	—	—	—
Sequential shooting/Self-timer	*1	*1	*1	*1	*1	*1	—	*1
Metering	—	—	—	—	—	—	—	—
Face priority	—	—	—	—	—	—	—	—
Accessory	*1	*1	*1	*1	*1	*1	*1	*1
Reset/Assign Custom Modes	✓	✓	✓	✓	✓	✓	✓	✓
AF Area	✓	✓	✓	✓	✓	✓	✓	—
Easy CALS	✓	✓	✓	✓	✓	✓	✓	✓

Interval Shooting	—	—	—	—	—	—	—	—
Focus BKT	—	—	—	—	—	—	—	—
Focus Stacking Settings	✓	✓	✓	✓	✓	✓	✓	✓
Date stamp	✓	—	✓	✓	✓	✓	—	✓
Picture + Sound	✓	—	✓	✓	✓	✓	—	✓
Movie	✓	—	✓	✓	✓	✓	—	✓
Recording Volume	✓	—	✓	✓	✓	✓	—	✓
Video Frame Rate	✓	✓	✓	✓	✓	✓	✓	✓
Video Bit Rate	✓	✓	✓	✓	✓	✓	✓	✓

Exposure compensation	—	—	—	—	—	✓	—	—
Picture mode	—	—	—	—	—	—	—	—
ISO sensitivity	—	—	—	—	—	—	—	—
White balance	—	—	—	—	—	✓	—	—
AF mode	—	—	—	—	—	—	—	—
Aspect ratio	✓	✓	✓	✓	✓	—	✓	✓
Image quality	✓	✓	✓	✓	✓	—	*1	✓
Movie quality	*1	*1	*1	*1	*1	*1	*1	*1
Image stabilizer	—	✓	✓	✓	✓	✓	✓	✓
Image stabilizer	—	—	—	—	—	—	—	—
Flash	—	*1	*1	—	*1	—	—	—
Flash intensity control	—	—	—	—	—	—	—	—
Sequential shooting/Self-timer	—	*1	*1	*1	*1	—	—	*1
Metering	—	—	—	—	—	—	—	—
Face priority	—	—	—	—	—	—	—	—
Accessory	*1	*1	*1	*1	*1	*1	*1	*1
Reset/Assign Custom Modes	✓	✓	✓	✓	✓	✓	✓	✓
AF Area	✓	✓	✓	✓	✓	*1	✓	✓
Easy CALS	✓	✓	✓	✓	✓	✓	✓	✓
Interval Shooting	—	—	—	—	—	—	—	—
Focus BKT	—	—	—	—	—	—	—	—

Focus Stacking Settings	✓	✓	✓	✓	✓	✓	✓	✓
Date stamp	—	✓	✓	✓	✓	—	—	✓
Picture + Sound	—	✓	✓	✓	✓	—	—	✓
Movie	—	✓	✓	✓	✓	—	—	✓
Recording Volume	—	✓	✓	✓	✓	—	—	✓
Video Frame Rate	✓	✓	✓	✓	✓	✓	✓	✓
Video Bit Rate	✓	✓	✓	✓	✓	✓	✓	✓

						
Exposure compensation	✓	✓	✓	✓	✓	✓
Picture mode	—	—	—	—	—	—
ISO sensitivity	—	—	—	—	—	—
White balance	✓	✓	✓	✓	✓	✓
AF mode	—	—	—	—	—	—
Aspect ratio	✓	✓	✓	✓	✓	✓
 Image quality	✓	✓	✓	✓	✓	✓
 Movie quality	*1	*1	*1	*1	*1	*1
 Image stabilizer	✓	✓	✓	✓	✓	✓
 Image stabilizer	—	—	—	—	—	—
Flash	—	—	—	*1	—	—
Flash intensity control	—	—	—	—	—	—
Sequential shooting/Self-timer	*1	*1	*1	*1	*1	*1
Metering	—	—	—	—	—	—
Face priority	—	—	—	—	—	—
Accessory	*1	*1	*1	*1	*1	*1
Reset/Assign Custom Modes	✓	✓	✓	✓	✓	✓
AF Area	✓	✓	✓	✓	✓	*1
Easy CALS	✓	✓	✓	✓	✓	✓
Interval Shooting	—	—	—	—	—	—
Focus BKT	—	—	—	—	—	—

						
Focus Stacking Settings	✓	✓	✓	✓	✓	✓
Date stamp	✓	✓	✓	✓	✓	✓
Picture + Sound	✓	✓	✓	✓	✓	✓
Movie 	—	—	—	—	—	—
Recording Volume	—	—	—	—	—	—
Video Frame Rate	✓	✓	✓	✓	✓	✓
Video Bit Rate	✓	✓	✓	✓	✓	✓

Default Settings

[Direct Button \(P.217\)](#)

[Live Control \(P.218\)](#)

 [Shooting Menus \(P.219\)](#)

 [Video Menu \(P.221\)](#)

 [Playback Menu \(P.222\)](#)

 [Custom Menus \(P.223\)](#)











 [Setup Menu \(P.226\)](#)

Direct Button

*1: Items that can be stored in **[Custom Mode C1]** or **[Custom Mode C2]**.

*2: Default settings will be restored for this function when **[Reset]** (Full) is performed.

*3: Default settings will be restored for this function when **[Reset]** (Basic) is performed.

Function	Default	*1	*2	*3	
Exposure compensation	±0.0	✓	✓	✓	
Flash	For [] in  mode and [], [], and [] in  mode		✓	✓	✓
	For [] in  mode	AUTO	✓	✓	✓
	All other modes		✓	✓	✓
Sequential shooting/Self-timer	<input type="checkbox"/>	✓	✓	✓	

Live Control

*1: Items that can be stored in **[Custom Mode C1]** or **[Custom Mode C2]**.

*2: Default settings will be restored for this function when **[Reset]** (Full) is performed.

*3: Default settings will be restored for this function when **[Reset]** (Basic) is performed.

Function	Default	*1	*2	*3	
Picture mode	Natural	✓	✓	✓	
ISO sensitivity	AUTO	✓	✓	✓	
White balance	AUTO	✓	✓	✓	
AF mode	AF	✓	✓	✓	
Aspect ratio	4:3	✓	✓	✓	
 Image quality	 F	✓	✓	✓	
 Movie quality	1920×1080 Fine 30p	✓	✓	✓	
 Image stabilizer	ON	✓	✓	✓	
 Image stabilizer	ON	✓	✓	✓	
Flash	For  in  mode and  ,  , and  in  mode		✓	✓	✓
	For  in  mode	AUTO	✓	✓	✓
	All other modes		✓	✓	✓
Flash intensity control	±0.0	✓	✓	✓	
Sequential shooting/Self-timer	<input type="checkbox"/>	✓	✓	✓	
Metering		✓	✓	✓	
Face priority	OFF	✓	✓	✓	
Accessory	OFF	✓	✓	✓	

Shooting Menus

*1: Items that can be stored in **[Custom Mode C1]** or **[Custom Mode C2]**.

*2: Default settings will be restored for this function when **[Reset]** (Full) is performed.

*3: Default settings will be restored for this function when **[Reset]** (Basic) is performed.

Shooting Menu 1

Function	Default	*1	*2	*3	
Reset/Assign Custom Modes	Reset	Basic	—	—	—
	Custom Mode C1	—	—	✓	—
	Custom Mode C2	—	—	✓	—
Picture mode	Natural	✓	✓	—	
AF Area	[·]	✓	✓	✓	
Easy CALS	Off	—	✓	✓	

Shooting Menu 2

Function	Default	*1	*2	*3
Interval Shooting	Off	—	✓	✓

Function		Default	*1	*2	*3
	Number of Frames	99	—	✓	✓
	Start Waiting Time	00:00:01	—	✓	✓
	Interval Length	00:00:01	—	✓	✓
	Interval Mode	Time Priority	—	✓	✓
	Exposure Smoothing	On	—	✓	✓
	Time Lapse Movie	Off	—	✓	✓
	Movie Settings	Movie Resolution	FullHD	—	✓
		Frame rate	10fps	—	✓
Focus BKT		Off	✓	✓	✓
	Start Waiting Time	0 sec	✓	✓	✓
	Set number of shots	30	✓	✓	✓
	Set focus differential	Normal	✓	✓	✓
	Start Waiting Time	0 sec	✓	✓	✓
	Set number of shots	8	✓	✓	✓
Date stamp		Off	✓	✓	✓
Picture + Sound		Off	✓	✓	✓

Video Menu

*1: Items that can be stored in **[Custom Mode C1]** or **[Custom Mode C2]**.

*2: Default settings will be restored for this function when **[Reset]** (Full) is performed.

*3: Default settings will be restored for this function when **[Reset]** (Basic) is performed.



Function	Default	*1	*2	*3
Movie 	On	—	✓	—
Recording Volume	±0	—	✓	—
Video Frame Rate	30p	—	✓	—
Video Bit Rate	Fine	—	✓	—

Playback Menu

*1: Items that can be stored in **[Custom Mode C1]** or **[Custom Mode C2]**.

*2: Default settings will be restored for this function when **[Reset] (Full)** is performed.

*3: Default settings will be restored for this function when **[Reset] (Basic)** is performed.

Function		Default	*1	*2	*3	
	Start	—	—	—	—	
	BGM	On	—	✓	✓	
	Slide	All	—	✓	✓	
	Slide Interval	3 sec	—	✓	—	
	Movie Interval	Short	—	✓	—	
		On	—	✓	✓	
Edit	Sel. Image	RAW Data Edit	—	✓	✓	✓
		JPEG Edit	—	—	—	—
		Movie Edit	—	—	—	—
		—	—	—	—	
	Image Overlay	—	—	—	—	
	Print Order	—	—	—	—	
	Reset Protect	—	—	—	—	
	Reset share Order	—	—	—	—	
	Device Connection	—	—	—	—	

Custom Menus

*1: Items that can be stored in **[Custom Mode C1]** or **[Custom Mode C2]**.





*2: Default settings will be restored for this function when **[Reset]** (Full) is performed.

*3: Default settings will be restored for this function when **[Reset]** (Basic) is performed.

A AF/MF

Function		Default	*1	*2	*3
AF Illuminator		Off	✓	✓	✓
MF Assist	Magnify	Off	✓	✓	—
	Peaking	Off	✓	✓	—

B Disp//PC

Function		Default	*1	*2	*3
 /Info Settings	 Info	Image only, Overall	✓	✓	✓
	LV-Info	Custom1 () , Custom2 (Level Gauge)	✓	✓	✓
	 Settings	25, Calendar	✓	✓	—
Live View Boost		Off	✓	✓	✓
Flicker Reduction		Auto	✓	✓	—
Displayed Grid		Off	✓	✓	—
Peaking Color		White	✓	✓	—
		3	✓	✓	✓
HDMI	Output Size	1080p	—	✓	—
	HDMI Control	Off	—	✓	—

C Exp/ISO

Function		Default	*1	*2	*3
Exposure Shift		±0	✓	✓	—
		±0	✓	✓	—
ISO-Auto Set	Upper Limit / Default	Upper Limit: 1600 Default: 100	✓	✓	✓
	Lowest S/S Setting	Auto	✓	✓	✓
Noise Filter		Standard	✓	✓	✓
Noise Reduct.		Auto	✓	✓	✓

D ⚡ Custom

Function	Default	*1	*2	*3
	Off	✓	✓	✓
	WB AUTO	✓	✓	—

E /WB/Color

Function	Default	*1	*2	*3
Set	1: L SF 2: L F 3: L N 4: M N	✓	✓	✓
WB	Auto	✓	✓	✓
WB AUTO Keep Warm Color	On	✓	✓	✓
Color space	sRGB	✓	✓	✓

F Record

Function		Default	*1	*2	*3
File Name		Reset	—	✓	—
Edit Filename		Off	—	✓	—
Copyright Settings	Copyright Info.	Off	—	✓	—
	Artist Name	—	—	—	—
	Copyright Name	—	—	—	—

G Field Sensor

Function		Default	*1	*2	*3
Record GPS location		Off	—	✓	—
Elevation/Temperature	Calibrate Elevation	—	—	✓	—
	m/ft	m	—	✓	—
	°C/°F	°C	—	✓	—

H Utility

Function	Default	*1	*2	*3
Pixel Mapping	—	—	—	—
Level Adjust	—	—	✓	—
Sleep	1 min	—	✓	✓
Certification	—	—	—	—

Setup Menu

*1: Items that can be stored in **[Custom Mode C1]** or **[Custom Mode C2]**.

*2: Default settings will be restored for this function when **[Reset]** (Full) is performed.

*3: Default settings will be restored for this function when **[Reset]** (Basic) is performed.

Function		Default	*1	*2	*3
Card Setup		—	—	—	—
⌚ Settings		—	—	—	—
	⌚	—	—	—	—
	Time Zone	—	—	—	—
	Auto Time Adjust	Off	—	—	—
🗣️		English	—	—	—
📶		☀️ ±0	—	✓	—
Image Review		0.5 sec	✓	✓	—
Wi-Fi/Bluetooth Settings	Wireless Function	On	—	✓	—
	Bluetooth	Off	—	✓	—
	Wireless Shutter Setting	—	—	—	—
	Connection Password	—	—	—	—
	Reset Settings	—	—	—	—
Construction Menu		Off	—	—	—

Memory Card Capacity

Number of still pictures

Figures are for a 64 GB SDXC card used to record photos with an aspect ratio of 4:3.

Image quality	Image size (Pixel count)	Compression ratio	File format	Number of storable still pictures
RAW	4000×3000	Lossless compression	ORF	4518
L SF		1/2.7	JPEG	6971
L F		1/4		10166
L N		1/8		19520
M1 SF	3200×2400	1/2.7		10608
M1 F		1/4		15250
M1 N		1/8		28706
M2 SF	1920×1440	1/2.7		27111
M2 F		1/4		37538
M2 N		1/8		61000
S SF	1280×960	1/2.7		54222
S F		1/4		69715
S N		1/8		97601

- The number of storable still pictures may change according to the subject, whether or not print orders have been made, and other factors. In certain instances, the number of storable still pictures displayed on the monitor will not change even when you take pictures or erase stored images.
- The actual file size varies according to the subject.
- The maximum number of storable still pictures displayed on the monitor is 9999.

- When **[Construction Menu]** is set to **[On]**, **M1** is displayed as **M**, **M2** is displayed as **CALSH**, and **S** is displayed as **CALS**.

Memory card capacity: movies

Figures are for a 64 GB SDXC memory card.

















Image size/bit rate/frame rate		Capacity (approx.)
 3840×2160 30p	3840×2160 30p	1 hour 21 minutes
 3840×2160 25p		
 1920×1080 Super Fine 60p	1920×1080 Super Fine 60p	2 hours 40 minutes
 1920×1080 Super Fine 50p		
 1920×1080 Super Fine 30p		
 1920×1080 Super Fine 25p		
 1920×1080 Fine 60p		
 1920×1080 Fine 50p	1920×1080 Fine 60p	4 hours 40 minutes
 1920×1080 Fine 30p		
 1920×1080 Fine 25p		
 1920×1080 Normal 60p		
 1920×1080 Normal 50p	1920×1080 Normal 60p	7 hours 53 minutes
 1920×1080 Normal 30p		
 1920×1080 Normal 25p		
 1280×720 Super Fine 30p		
 1280×720 Super Fine 25p	1280×720 Super Fine 30p	5 hours 24 minutes
 1280×720 Fine 30p	1280×720 Fine 30p	
 1280×720 Fine 25p		

Image size/bit rate/frame rate		Capacity (approx.)
HD 30p	1280×720 Normal 30p	14 hours 32 minutes
HD 25p	1280×720 Normal 25p	

- The maximum size of a single movie file is limited to 4 GB.
- The maximum recording time of a single movie is limited to 29 minutes.

Cautions

Water and shock resistance

This product is waterproof and shockproof.

- Water resistance: The camera is certified under JIS/IEC protection class 8 (IPX8)¹ and can be used to shoot at water depths of up to 15m.
- Shock resistance: The camera has cleared drop tests conducted under conditions specified by our company.

1 Indicates that the camera can be used under water for a specified amount of time and under a specified amount of water pressure.

- **The indicated water and shock resistance of this product are based on in-house testing conditions and do not guarantee against damage or failure.**

Using the camera underwater

Before using the camera underwater

- Check the seals of the battery/card compartment cover and connector cover and their contact surfaces for dust, sand, or other foreign matter. If any foreign matter is found on the gasket, remove it with a clean cloth that is free of fiber debris.
- Ensure that there are no cracks, scratches, or other defects on the seals of the battery/card compartment cover and connector cover or their contact surfaces.
- Firmly close the LOCK knob of the battery/card compartment cover and connector cover.
- Avoid opening and closing the battery/card compartment cover or connector cover near water (such as while at sea, on a lake, by the sea, or by a lake) or with wet hands.
- The camera sinks underwater.
- It cannot be used in hot springs.

When using the camera underwater

- Do not use the camera at depths greater than 15 m or underwater for more than 60 minutes.
- While underwater, do not open or close the battery/card compartment cover or connector cover.
- Do not subject the camera to shock, such as by diving into the water with force. The shock may cause the battery/card compartment cover or connector cover to open.

After using the camera underwater

- Using a cloth that is free of fiber debris, thoroughly wipe off any water droplets or dirt of the camera, then open the battery/card compartment cover and connector cover.

- Open the battery/card compartment cover and connector cover slowly in the orientation shown in the figure to prevent water droplets from entering the inside of the covers. If water droplets come into contact with the inside surface of the covers, be sure to wipe them before use.

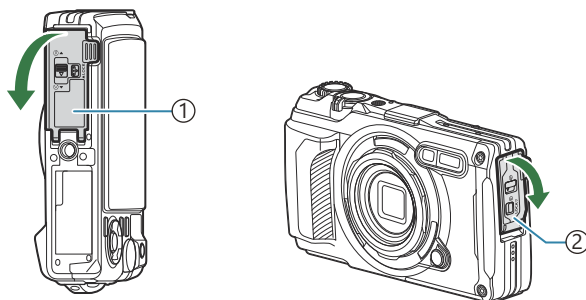

① Battery/card compartment cover

② Connector cover

Storage and maintenance

- Do not use chemicals for cleaning, rust prevention, anti-fogging, repair, or other maintenance. Doing so may break down water resistance.
- **When you have finished using the camera underwater, firmly close the battery/card compartment cover and connector cover. After locking the covers, remove the lens ring and soak the camera in a bucket or other container filled with clean water for about 10 minutes, then allow it to dry in the shade in a well-ventilated environment.**
- **After using the camera underwater, do not allow 60 or more minutes to pass without soaking it in clean water. Failure to observe this caution may result in damage to the camera's appearance and deterioration of its water resistance.**
- **To maintain water resistance, we recommend replacing the waterproof seals once a year. (You will be charged for replacement of the waterproof seals.)**
For distributors and repair stores that can replace the waterproof seals, please refer to our website.

Other cautions

- The accessories included with this product (such as the rechargeable battery) are not waterproof.
- Subjecting the camera to shocks may break down water resistance.
- The camera is not subject to waterproof with the battery/card compartment cover or connector cover opened.

Batteries

- The camera uses our lithium-ion battery. Never use any battery other than our genuine batteries.
- The camera's power consumption varies widely with usage and other conditions.
- As the following consume a lot of power even without shooting, the battery will be drained quickly.
 - Using the zoom repeatedly
 - Performing auto focus repeatedly by pressing the shutter button halfway in shooting mode
 - Displaying images on the monitor for a prolonged period
 - Connecting the camera to a computer
 - Leaving wireless LAN/**Bluetooth**® enabled
 - Using GPS
- When using a drained battery, the camera may turn off without the low battery warning being displayed.
- Remove the batteries before putting the camera into storage for periods of a month or more. Leaving the batteries in the camera for extended periods shortens their lives, potentially rendering them unusable.
- The normal charging time using the optional USB-AC adapter is approximately 3 hours (estimated). Charging times may increase at high ambient temperatures.
- Do not use USB-AC adapters or chargers not specifically designated for use with batteries of the supplied type. Similarly, do not use the supplied USB-AC adapter with batteries (cameras) other than those of the designated type.
- There is a risk of explosion if the battery is replaced with the incorrect battery type.
- Dispose of the used battery following the instructions "CAUTION" in the instruction manual.
- To ensure stable operation, please keep the battery inserted even when using the USB-AC adapter.

Using your USB-AC adapter abroad

- The USB-AC adapter (F-5AC) can be used with most home electrical sources within the range of 100 V to 240 V AC (50/60 Hz) around the world. However, depending on the country or area you are in, the AC wall outlet may be shaped differently and the USB-AC adapter may require a plug adapter to match the wall outlet.
- The illustration shows one example of a commercially available plug adapter. For details, check with an electronics store or a travel agent.

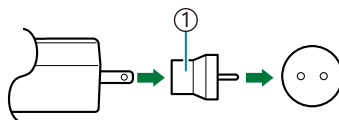

① Commercially available plug adapter

- Do not use third-party travel adapters as the USB-AC adapter may malfunction.

Information

Using Separately Sold Accessories

Attaching optional silicone jackets

Attach the jacket as shown. Reverse the steps to remove the jacket.

- Do not use excessive force. Failure to observe this precaution could damage the jacket.

1.

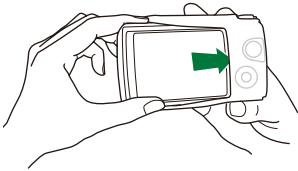

2.



Precautions for using silicone jackets

- Be careful not to let any foreign matter such as dust or sand enter the space between this product and the camera, as this can result in scratches.
- If the silicone jacket gets dirty, wash it with water and allow it to dry completely before use.
- Due to the non-slip property of silicone, the camera does not fit easily into a camera case when the silicone jacket is on.

Taking pictures with the Wireless RC Flash System

You can take pictures and underwater pictures with a wireless flash when using a flash compatible with the Wireless RC Flash System.

The setup range for wireless flash shooting varies depending on the environment, but the standard range is 1 to 2 m from the camera's built-in flash.



- The camera's built-in flash is used for communication between the camera and flash.
- To use a dedicated underwater strobe, prepare an underwater case, a fiber-optic cable, and other equipment.
- For details on the operation of wireless flash and underwater strobes, refer to the instruction manual for the dedicated external flash device or the underwater case.

1. Turn on the dedicated strobe.
 2. Set the flash mode of the dedicated strobe to RC mode.
 - If channel and group settings are required, select CH1 for the channel, and A for the group.
 3. Highlight Flash in Live Control and select [**RC**] (Remote Control) (P.64).
 4. Take a test shot to check the operation of the flash and the resulting image.
- Be sure to check the charge level of the camera and wireless flash before taking pictures.
 - When the camera flash is set to [**RC**], the camera's built-in flash is used for communication with the wireless flash. It cannot be used for taking pictures.
 - To take pictures with wireless flash, point the remote sensor of the special external flash toward the camera, and point the flash in the direction of the subject.

Optional accessories

Using optional accessories allows you enjoy shooting in various ways.

To attach an accessory, remove the lens ring that comes with the camera.

LED Light Guide (LG-1)	Prevents uneven illumination of the macro LED when shooting in  (Microscope) mode or during macro shooting. <ul style="list-style-type: none"> • Do not use flash. • This accessory cannot be used underwater.
Flash Diffuser (FD-1)	Allows you to get close to the subject for flash photography when shooting in  (Microscope) mode or during macro shooting.
Lens Barrier (LB-T01)	Prevents smudges and scratches from appearing on the lens surface when shooting or carrying the lens. <ul style="list-style-type: none"> • This accessory cannot be used at the same time as a silicone jacket.
Fisheye Converter (FCON-T01) ¹	Allows you to shoot wider scenes.
Circular Fisheye Converter (FCON-T02) ¹	Take both circular fisheye and diagonal fisheye shots by simply changing the zoom position.

Tele Converter (TCON-T01) ¹	Allows you to objects that are farther away.
Protection Filter (PRF-D40.5 PRO) ¹	Prevents smudges and scratches from appearing on the lens surface when shooting or carrying the lens.

1 A converter adapter (CLA-T01) is required to attach this accessory to the camera.

- To use optional accessories, configure the accessory settings in Live Control.  [“Using optional accessories \(Accessory\)” \(P.88\)](#)
- After using the camera underwater, wash it with clean water.
- For more information, visit our website.

Removing and attaching the lens ring

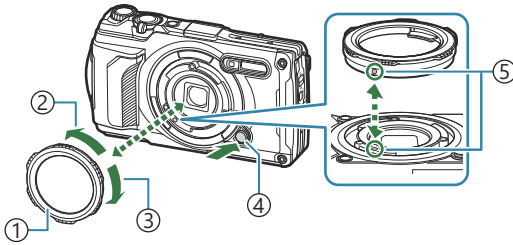

- ① Lens ring
- ② Detachment direction
- ③ Attachment direction
- ④ Lens ring release button
- ⑤ Attachment marker

Removing the accessory

Rotate the accessory in the detachment direction while pressing the lens ring release button.

Attaching the accessory

Align the accessory with the attachment marker and rotate it in the attachment direction until it clicks into place.

Attaching and removing the LED light guide

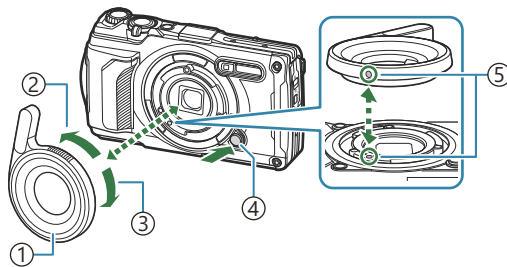

- ① LED light guide
- ② Detachment direction
- ③ Attachment direction
- ④ Lens ring release button
- ⑤ Attachment marker

Attaching the accessory

Align the accessory with the attachment marker and rotate it in the attachment direction until it clicks into place.

Removing the accessory

Rotate the accessory in the detachment direction while pressing the lens ring release button.

Attaching and removing the flash diffuser

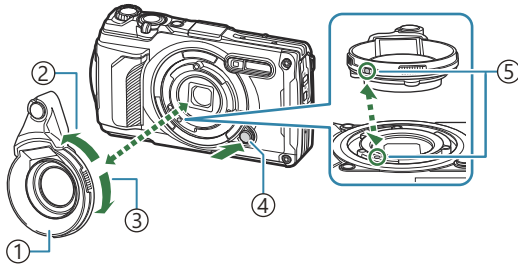

- ① Flash diffuser
- ② Detachment direction
- ③ Attachment direction
- ④ Lens ring release button
- ⑤ Attachment marker

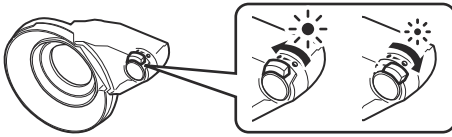

The light intensity can be switched.

Attaching the accessory

Align the accessory with the attachment marker and rotate it in the attachment direction until it clicks into place.

Removing the accessory

Rotate the accessory in the detachment direction while pressing the lens ring release button.

Attaching and removing the lens barrier

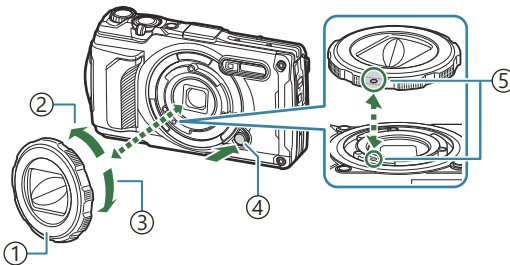

- ① Lens barrier
- ② Detachment direction
- ③ Attachment direction
- ④ Lens ring release button
- ⑤ Attachment marker

Attaching the accessory

Align the accessory with the attachment marker and rotate it in the attachment direction until it clicks into place.

- The attachment marker is located on the back of the lens ring.

Removing the accessory

Rotate the accessory in the detachment direction while pressing the lens ring release button.

Attaching and removing the conversion lens/protection filter

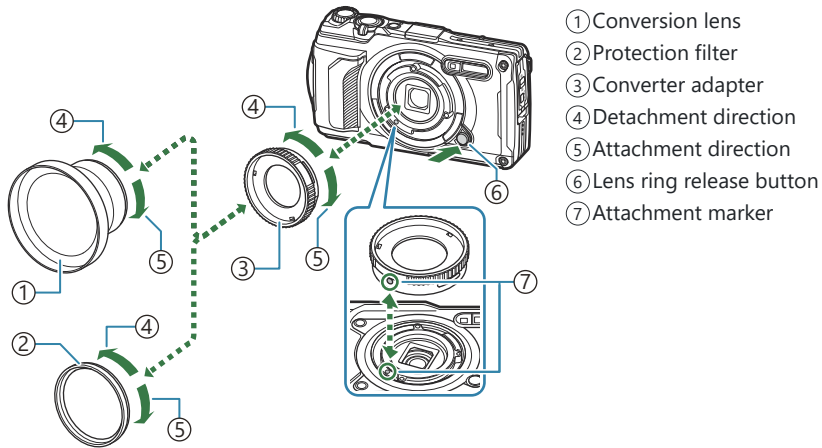

Attaching the accessory

1. Attach the converter adapter.
 - Align the accessory with the attachment marker and rotate it in the attachment direction until it clicks into place.
2. Rotate the conversion lens/protection filter in the attachment direction, and screw on the converter adapter.

Removing the accessory

1. Rotate the conversion lens/protection filter in the detachment direction.
2. Detach the converter adapter.
 - Rotate the accessory in the detachment direction while pressing the lens ring release button.

Cleaning and storing the camera

Cleaning the camera

Turn off the camera and remove the battery before cleaning the camera.

- Do not use strong solvents such as benzene or alcohol, or a chemically treated cloth.

Exterior:

- Wipe gently with a soft cloth. If the camera is very dirty, soak the cloth in mild soapy water and wring well. Wipe the camera with the damp cloth and then dry it with a dry cloth. If you have used the camera at the beach, soak the cloth in clean water and wring well.
- Foreign matter may adhere to the camera when using the camera in conditions where foreign matter such as dirt, dust or sand are present. If you continue to use the camera in such conditions, it could cause damage to the camera. To avoid such damage, wash the camera using the following method.

1. Close and lock the battery/card compartment cover and connector cover firmly (P.15).

2. Fill a bucket or other container with fresh water, immerse the camera facing downward in the bucket and shake the camera thoroughly. Furthermore, rinse the camera by placing it directly under a strong stream of tap water with pressing the button.



Monitor:

- Wipe gently with a soft cloth.

Lens:

- Cloths may scratch the lens if used without first removing sand, dust, or other foreign matter. Remove dust from the lens with a third-party blower and then gently clean it with lens cleaning paper.
- Mold may form on the lens surface if the lens is left dirty.

Battery/USB-AC adapter:



- Wipe gently with a soft, dry cloth.

Storage

- When not using the camera for a prolonged period, remove the battery and card. Store the camera in a cool, dry place that is well ventilated.
- Insert the battery periodically and test the camera's functions.
- Clean the camera after use.
- Do not store in the same place as insect repellent.
- In order to protect the camera from corrosion, avoid storing the camera in places where chemicals are treated.
- Mold may form on the lens surface if the lens is left dirty.
- Check each part of the camera before use if it has not been used for a long time. Before taking important pictures, be sure to take a test shot and check that the camera works properly.

Pixel Mapping - Checking the image processing functions

The pixel mapping feature allows the camera to check and adjust the image sensor and image processing functions. For best results, wait at least a minute after shooting and playback have ended before performing pixel mapping.

1. Highlight **[Pixel Mapping]** in  Custom Menu  (P.154).
 2. Press the **OK** button when **[Start]** (Submenu 2) is displayed.
 - The **[Busy]** bar is displayed when pixel mapping is in progress. When pixel mapping is finished, the menu is restored.
- If you accidentally turn the camera off during pixel mapping, start again from Step 1.

Shooting tips and information

The camera does not turn on even when a battery is loaded

The battery is inserted in the wrong direction

- If you insert the battery in the wrong direction, the camera will not turn on. Be sure to insert it in the correct direction.  ["Inserting the battery and card" \(P.19\)](#)

The battery is not fully charged

- Charge the battery.  ["Charging the Battery" \(P.23\)](#)

The battery is temporarily unable to function because of the cold

- Battery performance drops at low temperatures. Remove the battery and warm it by putting it in your pocket for a while.

A dialog prompting you to choose a language is displayed

The dialog is displayed in the following situations.

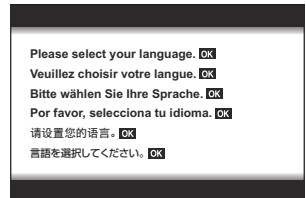

- The camera is turned on for the first time.
- You have not chosen a language.



See ["Initial Setup" \(P.28\)](#) for information on choosing a language.

No picture is taken when the shutter button is pressed

The camera has turned off automatically

- The camera automatically enters sleep mode to reduce the drain on the battery if no operations are performed for a set period of time. Press the shutter button halfway to exit sleep mode. The camera will turn off automatically if left in sleep mode for 5 minutes.   Custom Menu  > [Sleep] (P.154)

The flash is charging

- On the monitor, the  mark blinks when charging is in progress. Wait for the blinking to stop, then press the shutter button.

The camera temperature is elevated

- The camera may shut down if its internal temperature rises after extended use. Remove the battery and wait until the internal temperature has dropped enough for the camera to be used again. The camera may also become warm to the touch during use, but this does not indicate a malfunction.

Unable to focus

- The camera cannot focus on subjects that are too close to the camera or that are not suited to Auto Focus (the AF confirmation mark will blink in the monitor). Increase the distance to the subject or focus on a high contrast object at the same distance from the camera as your main subject, compose the shot, and shoot.

Subjects that are difficult to focus on

It may be difficult to focus using Auto Focus in the following situations.

- The AF confirmation mark is blinking.

The camera will not be able to focus under the following conditions.



Subject has low contrast



Excessively bright light in center of frame

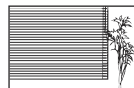

Subject contains no vertical lines¹

- The AF confirmation mark lights up, but the subject is not in focus.



Subjects at different distances





Fast-moving subject



Subject not inside AF area

- 1 It is also effective to compose the shot by holding the camera vertically to focus, and then returning to the horizontal position to take the picture.

Noise reduction is activated

- When shooting night scenes, shutter speeds are slower and noise tends to appear in images. The camera activates the noise-reduction process after shooting at slow shutter speeds. During this process, shooting is not possible. You can set **[Noise Reduct.]** to **[Off]**.   [Custom Menu](#)
 > [\[Noise Reduct.\]](#) (P.147)

The date and time have not been set

The camera is used with the settings at the time of purchase

- The date and time of the camera are not set when purchased. Set the date and time before using the camera.  ["Initial Setup" \(P.28\)](#)

The battery has been removed from the camera

- The date and time settings will revert to the factory default settings if the camera is left without the battery for approximately 1 day (according to in-house experiments). The settings will revert more quickly if the battery was only loaded in the camera for a short amount of time before being removed. Before taking important pictures, check that the date and time settings are correct.



Set functions are restored to their factory default settings

In shooting modes other than **P/A**/, rotating the mode dial or turning off the power reverts the set functions to their default settings.

Some settings are unavailable

Some features may be unavailable depending on the shooting mode and camera settings.  ["List of configurable shooting modes"](#) (P.206)

Pictures are grainy

- In  Image quality, set the pixel count to a higher value or set compression to SF or F.  ["Photo file and image size options \(Image quality\)"](#) (P.80)
- Image "noise" mottling can sometimes be reduced by lowering ISO sensitivity.  ["Changing ISO sensitivity \(ISO Sensitivity\)"](#) (P.74)

Pictures are "washed out"

This may occur when the picture is taken in backlit or semi-backlit conditions. This is due to a phenomenon called flare or ghosting. Frame the shot so that as few strong light sources as appear in the picture as possible. Flare may occur even when light sources are not present in the picture. Use your hand or other object to shade the lens from direct light sources.

Light appears in the picture

Shooting with flash in dark conditions results in images with the flash visibly reflected on specks of dust in the air.

Unknown bright dot(s) appear on the subject in the picture taken

This may be due to stuck pixel(s) on the image sensor. Perform **[Pixel Mapping]**. If this does not solve the problem, try performing Pixel Mapping multiple times.  ["Pixel Mapping - Checking the image processing functions"](#) (P.243)

The lens is cloudy or the monitor is hard to read

Rapid temperature changes may cause lens fogging (condensation) to occur. Turn off the power, and wait for the camera body to become acclimated to the surrounding temperature and dry out before taking pictures.

Movies do not play back smoothly when viewed on a TV

The movie frame rate may not match the video standard used in the TV. View the movie on a computer instead. Before recording movies for display on a TV, select a frame rate that matches the video standard used in the device.  [\[Video Frame Rate\] \(P.134\)](#)

The heading is not correct

The compass does not function as expected in the vicinity of strong electromagnetic fields, such as from televisions, microwaves, large electric motors, radio transmitters, and high-voltage power lines. Normal function can sometimes be restored by moving the camera in a figure eight while rotating your wrist.

Functions that cannot be selected from menus









Some items may not be selectable from the menus when using the arrow pad.





- Items that cannot be set with the current shooting mode.
- Items that cannot be set because of an item that has already been set:
 - Settings such as picture mode are unavailable when the mode dial is rotated to .



Only the subject is displayed and no information is shown

The display has been switched to “image only”. Press the **INFO** button and switch to another display mode.

Error codes

Monitor indication	Possible cause/Corrective action
 <p>No Card</p>	<p>No card inserted or card not recognized.</p> <p>Insert a card or remove and reinsert the current card.</p>
 <p>Card Error</p>	<p>There is a problem with the card.</p> <p>Insert the card again. If the problem persists, format the card. If the card cannot be formatted, it cannot be used.</p>
 <p>Write Protect</p>	<p>Writing to the card is prohibited.</p> <p>The card write-protect switch is set to the "LOCK" side. Return the switch to the unlocked position (P.21).</p>
 <p>Card Full</p>	<p>The card is full and no additional pictures can be taken.</p> <p>Replace the card or erase unwanted pictures. Before erasing, download important images to a PC.</p>
 <p>Card Full</p>	<p>There is no space in the card.</p> <p>Replace the card or erase unwanted pictures. Before erasing, download important images to a PC.</p>
 <p>No Picture</p>	<p>There are no pictures to play back.</p> <p>The card contains no pictures. Take pictures before beginning playback.</p>
 <p>Picture Error</p>	<p>The selected file is damaged and cannot be played back. Alternatively, the picture is in a format that is not supported by the camera.</p> <p>View the picture using computer imaging software or another method. If the picture cannot be displayed on a computer, the file may be corrupt.</p>
 <p>The Image Cannot Be Edited</p>	<p>Camera retouch features cannot be applied to pictures recorded with other devices.</p> <p>Retouch the picture on a computer or other device.</p>

Monitor indication	Possible cause/Corrective action
<p>Y/M/D</p>	<p>The clock is not set. Set the clock (P.28).</p>
	<p>The internal temperature of the camera has risen due to sequential shooting. Turn off the camera and wait for the internal temperature to cool.</p>
 <p>Internal camera temperature is too high. Please wait for cooling before camera use.</p>	<p>The internal temperature of the camera has risen due to sequential shooting. Wait a moment for the camera to turn off automatically. Allow the internal temperature of the camera to cool before resuming operations.</p>
 <p>Battery Empty</p>	<p>The battery is exhausted. Charge the battery.</p>
 <p>No Connection</p>	<p>The camera is not correctly connected to a computer, HDMI display, or other devices. Reconnect the camera.</p>
 <p>Logging function cannot be used at this time.</p>	<p>The area of camera memory used for temporary storage of the log file is full. Insert a card or confirm that the current card is correctly inserted and transfer to log file to the card.</p>
	<p>The battery is exhausted. Charge the battery.</p>
	<p>The camera is connected to a television or other device via an HDMI cable. Disconnect the HDMI cable.</p>
<p>The USB-AC adapter is being used to supply power to the camera from an electrical outlet while the battery is removed. Insert the battery and unplug the USB-AC adapter from the outlet.</p>	



Monitor indication	Possible cause/Corrective action
 <p>Card log capacity is full. Cannot record new log files.</p>	<p>The current log cannot be saved to the card.</p> <p>Copy log files to a computer and delete them from the card.</p> <ul style="list-style-type: none"> • Each card can store up to 199 log files.
 <p>(Blinking)</p>	<p>The current log has not been saved to the card.</p> <p>Insert a card or confirm that the current card is correctly inserted and transfer to log file to the card.</p>
	<p>The current log cannot be saved to the card.</p> <p>Copy log files to a computer and delete them from the card.</p> <ul style="list-style-type: none"> • Each card can store up to 199 log files.
	<p>There is a problem with the card.</p> <p>Insert a new card.</p>
	<p>Writing to the card is prohibited.</p> <p>The card write-protect switch is set to the “LOCK” side. Return the switch to the unlocked position (P.21).</p>
<p>There is no space in the card.</p> <p>Replace the card or erase unwanted pictures. Before erasing, download important images to a PC.</p>	

Monitor indication	Possible cause/Corrective action
 <p>(Solid)</p>	<p>The area of camera memory used for temporary storage of the log file is full.</p> <p>Insert a card or confirm that the current card is correctly inserted and transfer to log file to the card.</p>
	<p>The battery is exhausted.</p> <p>Charge the battery.</p>
	<p>The camera is connected to a television or other device via an HDMI cable.</p> <p>Disconnect the HDMI cable.</p>
	<p>The USB-AC adapter is being used to supply power to the camera from an electrical outlet while the battery is removed.</p> <p>Insert the battery and unplug the USB-AC adapter from the outlet.</p>
	<p>The clock is not set.</p> <p>Set the clock and select a time zone.</p>

Specifications

Camera

Model	
	Digital camera (for shooting and displaying)
Recording system	
Still pictures	Digital recording, JPEG (in accordance with Design rule for Camera File system (DCF)), RAW data
Applicable standards	Exif 2.31, Digital Print Order Format (DPOF)
Sound with still pictures	Wave format
Movie	MOV (MPEG-4AVC/H.264)
Memory	
	SD/SDHC/SDXC (supports UHS-I)
Total no. of pixels	
	Approx. 12.71 million
No. of effective pixels	
	12 million
Image pickup device	
	1/2.3" CMOS

Lens	
	4.5 mm to 18.0 mm, f2.0 to f4.9 (equivalent to 25 mm to 100 mm on 35 mm film)
Photometric system	
	Digital ESP metering, spot metering system
Shutter speed	
	1/2–1/2000 sec. (slowest shutter speed available increases to 4 sec. in A mode, 1/10–1/32000 sec. in  10fps and ^{Pro} Cap, 1/20–1/32000 sec. in  20fps)
Shooting range	
Normal	0.1 m (0.3 ft.) to ∞ (W/T)
Super macro	0.01 m (0.03 ft.) to 0.3 m (1.0 ft.) (f=5.4 mm to 18.0 mm)
Microscope mode	0.01 m (0.03 ft.) to 0.3 m (1.0 ft.) (f=5.4 mm to 18.0 mm)
Monitor	
	3.0" TFT color LCD display, Approx. 1.04 million dots
Connector	
	USB connector (Type-C)/HDMI connector (Type-D)
Automatic calendar system	
	2000 up to 2099

Water resistance	
Type	IEC 60529 IPX8 (under in-house test conditions), usable in 15 m (49.2 ft.) deep water
Meaning	The camera can be used under water for a specified amount of time and under a specified amount of water pressure.
Dust resistance	
	IEC 60529 IPX6
Wireless LAN	
Compatible standards	IEEE802.11b/g/n
Bluetooth®	
Compatible standards	Bluetooth Version 4.2 BLE
GPS	
Reception frequency	1575.42 MHz (GPS/Galileo/Quazi-Zenith Satellite System (QZSS)) 1598.0625 MHz to 1605.3750 MHz (GLONASS)
Geodetic system	WGS84
Operating environment	
Temperature	-10 °C to 40 °C (14 °F to 104 °F) (operation)/-20 °C to 60 °C (-4 °F to 140 °F) (storage)
Humidity	30% – 90% (operation)/10% – 90% (storage)
Power supply	
	One designated lithium ion battery (LI-92B) or USB-AC adapter (F-5AC)

Dimensions

113.9 mm (W) × 65.8 mm (H) × 32.7 mm (D) (4.5 × 2.6 × 1.3 in.)
(excluding protrusions)

Weight

249 g (8.9 oz) (including battery and card)

Lithium-ion battery

Model No.	LI-92B
Product type	Lithium ion rechargeable battery
Nominal voltage	DC3.6V
Standard voltage	1350mAh
Battery life	Approx. 300 full charges (varies on usage)
Ambient operating temperature	0 °C to 40 °C (32 °F to 104 °F) (charging)

- SPECIFICATIONS ARE SUBJECT TO CHANGE WITHOUT ANY NOTICE OR OBLIGATION ON THE PART OF THE MANUFACTURER.
- Visit our website for the latest specifications.

The terms HDMI and HDMI High-Definition Multimedia Interface, and the HDMI Logo are trademarks or registered trademarks of HDMI Licensing Administrator, Inc. in the United States and other countries.



SAFETY PRECAUTIONS

SAFETY PRECAUTIONS



CAUTION

RISK OF ELECTRIC SHOCK
DO NOT OPEN



CAUTION: TO REDUCE THE RISK OF ELECTRICAL SHOCK, DO NOT REMOVE COVER (OR BACK). NO USER-SERVICEABLE PARTS INSIDE. REFER SERVICING TO QUALIFIED SERVICE PERSONNEL.



An exclamation mark enclosed in a triangle alerts you to important operating and maintenance instructions in the documentation provided with the product.



WARNING

If the product is used without observing the information given under this symbol, serious injury or death may result.



CAUTION

If the product is used without observing the information given under this symbol, injury may result.



NOTICE

If the product is used without observing the information given under this symbol, damage to the equipment may result.

WARNING!

TO AVOID THE RISK OF FIRE OR ELECTRICAL SHOCK, NEVER DISASSEMBLE THIS PRODUCT.

General Precautions

Read All Instructions — Before you use the product, read all operating instructions. Store all manuals and documentation for future reference.

Water and Moisture — For precautions on products with weatherproof designs, read the weatherproofing sections.

Power Source — Connect this product only to the power source described on the product label.

Foreign Objects — To avoid personal injury, never insert a metal object into the product.

Cleaning — Always unplug this product from the wall outlet before cleaning. Use only a damp cloth for cleaning. Never use any type of liquid or aerosol cleaner, or any type of organic solvent to clean this product.

Heat — Never use or store this product near any heat source such as a radiator, heat register, stove, or any type of equipment or appliance that generates heat, including stereo amplifiers.

Lightning — If a lightning storm occurs while using a USB-AC adapter, remove it from the wall outlet immediately.

Attachments — For your safety, and to avoid damaging the product, use only accessories recommended by our company.

Location — To avoid damage to the product, mount the product securely on a stable tripod, stand, or bracket.

WARNING

- **Do not use the camera near flammable or explosive gases.**
- **Do not use the flash and LED (including AF illuminator) on people (infants, small children, etc.) at close range.**
 - You must be at least 1 m (3 ft.) away from the faces of your subjects. Firing the flash too close to the subject's eyes could cause a momentary loss of vision.
- **Do not look at the sun or strong lights with the camera.**
- **Keep young children and infants away from the camera.**
 - Always use and store the camera out of the reach of young children and infants to prevent the following dangerous situations which could cause serious injury:
 - Becoming entangled in the camera strap, causing strangulation.
 - Accidentally swallowing the battery, cards or other small parts.
 - Accidentally firing the flash into their own eyes or those of another child.
 - Accidentally being injured by the moving parts of the camera.
- **If you find that the USB-AC adapter or charger is extremely hot or notice any unusual odors, noise, or smoke around it, unplug the power plug from wall outlet immediately and stop using it. Then, contact an authorized distributor or service center.**
- **Stop using the camera immediately if you notice any unusual odors, noise, or smoke around it.**
 - Never remove the batteries with bare hands, which may cause a fire or burn your hands.
- **Do not leave the camera in places where it may be subject to extremely high temperatures.**
 - Doing so may cause parts to deteriorate and, in some circumstances, cause the camera to catch fire. Do not use the charger or USB-AC adapter if it is covered (such as a blanket). This could cause overheating, resulting in fire.
- **Handle the camera with care to avoid getting a low-temperature burn.**
 - When the camera contains metal parts, overheating can result in a low-temperature burn. Pay attention to the following:
 - When used for a long period, the camera will get hot. If you hold on to the camera in this state, a low-temperature burn may be caused.
 - In places subject to extremely cold temperatures, the temperature of the camera's body may be lower than the environmental temperature. If possible, wear gloves when handling the camera in cold temperatures.

- To protect the high-precision technology contained in this product, never leave the camera in the places listed below, no matter if in use or storage:
 - Places where temperatures and/or humidity are high or go through extreme changes. Direct sunlight, beaches, locked cars, or near other heat sources (stove, radiator, etc.) or humidifiers.
 - In sandy or dusty environments.
 - Near flammable items or explosives.
 - In wet places, such as bathrooms or in the rain.
 - In places prone to strong vibrations.
- **The camera uses a lithium ion battery specified by our company.**
 Charge the battery with the specified USB-AC adapter or charger. Do not use any other USB-AC adapters or chargers.
- **Never incinerate or heat batteries in microwaves, on hot plates, or in pressure vessels, etc.**
- **Never leave the camera on or near electromagnetic devices.**
 This may cause overheating, burning, or exploding.
- **Do not connect terminals with any metallic objects.**
 - Take precautions when carrying or storing batteries to prevent them from coming into contact with any metal objects such as jewelry, pins, fasteners, keys, etc.
 The short circuit may cause overheating, exploding, or burning, which burn or damage you.
- **To prevent causing battery leaks or damaging their terminals, carefully follow all instructions regarding the use of batteries. Never attempt to disassemble a battery or modify it in any way, solder, etc.**
- **If battery fluid gets into your eyes, flush your eyes immediately with clear, cold running water and seek medical attention immediately.**
- **If you cannot remove the battery from the camera, contact an authorized distributor or service center.**
 Do not try to remove the battery by force.
 Damage to the battery exterior (scratches, etc.) may produce heat or an explosion.
- **Always store batteries out of the reach of small children and pets. If they accidentally swallow a battery, seek medical attention immediately.**
- To prevent batteries from leaking, overheating, or causing a fire or explosion, use only batteries recommended for use with this product.
- If rechargeable batteries have not been recharged within the specified time, stop charging them and do not use them.
- Do not use batteries with scratches or damage to the casing, and do not scratch the battery.
- Never subject batteries to strong shocks or continuous vibration by dropping or hitting.
 This may cause exploding, overheating, or burning.
- If a battery leaks, has unusual odor, becomes discolored or deformed, or becomes abnormal in any other way during operation, stop using the camera, and keep away from fire immediately.
- If a battery leaks fluid onto your clothing or skin, remove the clothing and flush the affected area with clean, running cold water immediately. If the fluid burns your skin, seek medical attention immediately.
- Never use lithium-ion batteries in a low-temperature environment. Doing so may cause generation of heat, ignition, or explosion.

- The lithium-ion battery is designed to be used only for the digital camera. Do not use the battery to other devices.
- **Do not allow children or animals/pets to handle or transport batteries (prevent dangerous behavior such as licking, putting in mouth or chewing).**

Use Only Dedicated Rechargeable Battery, Battery Charger and USB-AC adapter

We strongly recommend that you use only the genuine rechargeable battery, battery charger, and USB-AC adapter specified by our company with this camera. Using a non-genuine rechargeable battery, battery charger and/or USB-AC adapter may result in fire or personal injury due to leakage, heating, ignition or damage to the battery. Our company does not assume any liability for accidents or damage that may result from the use of a battery, battery charger, and/or USB-AC adapter that are not specified genuine accessories.

CAUTION

- **Never store batteries where they will be exposed to direct sunlight, or subjected to high temperatures in a hot vehicle, near a heat source, etc.**
- Keep batteries dry at all times.
- The battery may become hot during prolonged use. To avoid minor burns, do not remove it immediately after using the camera.
- This camera uses one of our lithium-ion batteries. Use the specified genuine battery. There is a risk of explosion if the battery is replaced with the incorrect battery type.
- Please recycle batteries to help save our planet's resources. When you throw away dead batteries, be sure to cover their terminals and always observe local laws and regulations.
- **Do not cover the flash with a hand while firing.**

NOTICE

- **Do not use or store the camera in dusty or humid places.**
- **Use SD/SDHC/SDXC cards only. Never use other types of cards.**

If you accidentally insert another type of card into the camera, contact an authorized distributor or service center. Do not try to remove the card by force.
- Regularly back up important data to a computer or other storage device to prevent accidental loss.
- Our company accepts no liability for any loss of data associated with this device.
- Be careful with the strap when you carry the camera. It could easily catch on stray objects and cause serious damage.
- Before transporting the camera, remove a tripod and all other accessories made by other companies.
- Never drop the camera or subject it to severe shocks or vibrations.

- When attaching the camera to or removing it from a tripod, rotate the tripod screw, not the camera.
- Do not touch electric contacts on cameras.
- Do not leave the camera pointed directly at the sun. This may cause lens or shutter curtain damage, color failure, ghosting on the image sensor, or may possibly cause fires.
- Do not leave the viewfinder exposed to a strong light source or direct sunlight. The heat may damage the viewfinder.
- Do not push or pull severely on the lens.
- Be sure to remove any water droplets or other moisture from the product before replacing the battery or opening or closing covers.
- Before storing the camera for a long period, remove the batteries. Select a cool, dry location for storage to prevent condensation or mold from forming inside the camera. After storage, test the camera by turning it on and pressing the shutter button to make sure that it is operating normally.
- The camera may malfunction if it is used in a location where it is subject to a magnetic/ electromagnetic field, radio waves, or high voltage, such as near a TV set, microwave, video game, loud speakers, large monitor unit, TV/radio tower, or transmission towers. In such cases, turn the camera off and on again before further operation.
- Always observe the operating environment restrictions described in the camera's manual.
- Insert the battery carefully as described in the operating instructions.
- Before loading, always inspect the battery carefully for leaks, discoloration, warping, or any other abnormality.
- Always unload the battery from the camera before storing the camera for a long period.
- When storing the battery for a long period, select a cool location for storage.
- Power consumption by the camera varies depending on which functions are used.
- During the conditions described below, power is consumed continuously and the battery becomes exhausted quickly.
 - The zoom is used repeatedly.
 - The shutter button is pressed halfway repeatedly in shooting mode, activating the auto focus.
 - A picture is displayed on the monitor for an extended period of time.
 - GPS is used.
- Using an exhausted battery may cause the camera to turn off without displaying the battery level warning.
- If the battery's terminals get wet or greasy, camera contact failure may result. Wipe the battery well with a dry cloth before use.
- Always charge a battery when using it for the first time, or if it has not been used for a long period.
- When operating the camera with battery power at low temperatures, try to keep the camera and spare battery as warm as possible. A battery that has run down at low temperatures may be restored after it is warmed at room temperature.
- Before going on a long trip, and especially before traveling abroad, purchase extra batteries. A recommended battery may be difficult to obtain while traveling.

Using the wireless LAN/Bluetooth® functions

- **Turn off the camera in hospitals and other locations where medical equipment is present.**

The radio waves from the camera may adversely affect medical equipment, causing a malfunction that results in an accident. Be sure to disable wireless LAN/**Bluetooth**® functions in the vicinity of medical equipment (P.172).

- **Turn off the camera when onboard aircraft.**

Using wireless devices onboard may hinder safe operation of the aircraft. Be sure to disable wireless LAN/**Bluetooth**® functions onboard aircraft (P.172).

Monitor

- Do not push the monitor forcibly; otherwise the image may become vague, resulting in a playback mode failure or damage to the monitor.
- A strip of light may appear on the top/bottom of the monitor, but this is not a malfunction.
- When a subject is viewed diagonally in the camera, the edges may appear zigzagged on the monitor. This is not a malfunction; it will be less noticeable in playback mode.
- In places subject to low temperatures, the monitor may take a long time to turn on or its color may change temporarily.

When using the camera in extremely cold places, it is a good idea to occasionally place it in a warm place. The monitor exhibiting poor performance due to low temperatures will recover in normal temperatures.

- The monitor of this product is manufactured with high-quality accuracy, however, there may be a stuck or dead pixel on the monitor. These pixels do not have any influence on the image to be saved. Because of the characteristics, the unevenness of the color or brightness may also be found depending on the angle, but this is due to the structure of the monitor. This is not a malfunction.

Legal and Other Notices

- Our company makes no representations or warranties regarding any damages, or benefit expected by using this unit lawfully, or any request from a third person, which are caused by the inappropriate use of this product.
- Our company makes no representations or warranties regarding any damages or any benefit expected by using this unit lawfully which are caused by erasing picture data.

Disclaimer of Warranty

- Our company makes no representations or warranties, either expressed or implied, by or concerning any content of these written materials or software, and in no event shall be liable for any implied warranty of merchantability or fitness for any particular purpose or for any consequential, incidental or indirect damages (including but not limited to damages for loss of business profits, business interruption and loss of business information) arising from the use or inability to use these written materials or software or equipment. Some countries do not allow the exclusion or limitation of liability for consequential or incidental damages or of the implied warranty, so the above limitations may not apply to you.

- Our company reserves all rights to this manual.

Warning

Unauthorized photographing or use of copyrighted material may violate applicable copyright laws. Our company assumes no responsibility for unauthorized photographing, use or other acts that infringe upon the rights of copyright owners.

Copyright Notice

All rights reserved. No part of these written materials or this software may be reproduced or used in any form or by any means, electronic or mechanical, including photocopying and recording or the use of any type of information storage and retrieval system, without the prior written permission of our company. No liability is assumed with respect to the use of the information contained in these written materials or software, or for damages resulting from the use of the information contained therein. Our company reserves the right to alter the features and contents of this publication or software without obligation or advance notice.

Trademarks

- SDXC Logo is a trademark of SD-3C, LLC.
- Apical logo is a registered trademark of Apical Limited.



- Wi-Fi is a registered trademark of the Wi-Fi Alliance.
- The **Bluetooth**® word mark and logos are registered trademarks owned by the Bluetooth SIG, Inc. and any use of such marks by OM Digital Solutions Corporation is under license.
- QR Code is a trademark of Denso Wave Inc.
- The standards for camera file systems referred to in this manual are the “Design Rule for Camera File System/DCF” standards stipulated by the Japan Electronics and Information Technology Industries Association (JEITA).
- All other company and product names are registered trademarks and/or trademarks of their respective owners. “™” and “®” symbols may sometimes be omitted.

THIS PRODUCT IS LICENSED UNDER THE AVC PATENT PORTFOLIO LICENSE FOR THE PERSONAL AND NONCOMMERCIAL USE OF A CONSUMER TO (i) ENCODE VIDEO IN COMPLIANCE WITH THE AVC STANDARD (“AVC VIDEO”) AND/OR (ii) DECODE AVC VIDEO THAT WAS ENCODED BY A CONSUMER ENGAGED IN A PERSONAL AND NON-COMMERCIAL ACTIVITY AND/OR WAS OBTAINED FROM A VIDEO PROVIDER LICENSED TO PROVIDE AVC VIDEO. NO LICENSE IS GRANTED OR SHALL BE IMPLIED FOR ANY OTHER USE. ADDITIONAL INFORMATION MAY BE OBTAINED FROM MPEG LA, L.L.C. SEE [HTTP://WWW.MPEGLA.COM](http://www.mpegla.com)

The software in this camera may include third party software. Any third party software is subject to the terms and conditions, imposed by the owners or licensors of that software, under which software is provided to you.

Those terms and other third party software notices, if any, may be found in the software notice PDF file stored at

<https://support.jp.omsystem.com/en/support/imshow/digicamera/download/notice/notice.html>

date of issue 2023.09.



<https://www.om-digitalsolutions.com/>